

**STEREO SOUND 8mm PROJECTOR**

**ELMO**

**GS-1200**

**INSTRUCTION MANUAL**



# IMPORTANT SAFEGUARDS

When using your photographic equipment, basic safety precautions should always be followed, including the following :

1. Read and understand all instructions.
2. Close supervision is necessary when any appliance is used by or near children. Do not leave appliance unattended while in use.
3. Care must be taken as burns can occur from touching hot parts.
4. Do not operate appliance with a damaged cord or if the appliance has been dropped or damaged-until it has been examined by a qualified serviceman.
5. Do not let cord hang over edge of table or counter or touch hot surfaces.
6. If an extension cord is necessary, a cord with a suitable current rating should be used. Cords rated for less amperage than the appliance may overheat. Care should be taken to arrange the cord so that it will not be tripped over or pulled.
7. Always unplug appliance from electrical outlet when not in use. Never yank cord to pull plug from outlet. Grasp plug and pull to disconnect.
8. Let appliance cool completely before putting away. Loop cord loosely around appliance when storing.
9. To protect against electrical shock hazards, do not immerse this appliance in water or other liquids.
10. To avoid electric shock hazard, do not disassemble this appliance, but take it to a qualified serviceman when some service or repair work is required. Incorrect reassembly can cause electric shock hazard when the appliance is used subsequently.

## SAVE THESE INSTRUCTIONS

# CONTENTS

Page

Introduction .....	2
--------------------	---

## PROJECTION

Checking the position of switches and knobs before projection .....	4
Image adjustment .....	6
Projection .....	10
Reverse projection .....	16
Still projection .....	16
Slow projection .....	17
Remote control projection .....	18
Public address system .....	19
Reproducing sound through a stereo set .....	20
Connecting the extension speakers .....	20
Using the level meter during playback .....	21
Removing the film from the film path .....	22
Rewinding .....	23

## RECORDING

Recording procedure .....	26
Stereo recording .....	32
Monaural recording .....	32
Monitoring .....	33
Adding sound to simultaneously recorded film (Recording on Track 2) .....	33
Track to track sound transfer .....	34
Spot recording .....	36
Double (Sound on Sound) recording .....	37
Projection speed adjustment during recording .....	39

## PULSE-SYNC PROJECTION

Pulse-sync projection .....	42
How to transfer the pulse system sync-sound to the sound stripe .....	46
Pulse recording .....	47
Microphone .....	48

## MAINTENANCE AND CHECK

Cleaning .....	50
Replacing projection lamp .....	51
Replacing exciter lamp .....	52
Changing the projection lens .....	53
Voltage selection .....	53
Trouble-shooting hints .....	54
Optional accessories .....	56
Accessory cords .....	60
Block diagram .....	61
Projection distance and image size .....	64
Projection time and film length .....	65
Specifications .....	66

# INTRODUCTION

Track 1  
(L Channel)

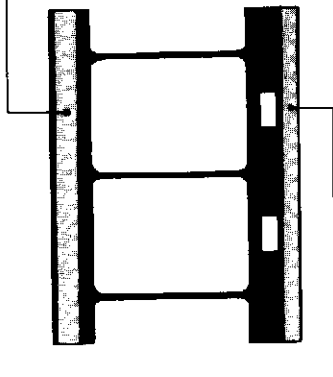

Track 2  
(R Channel)

All Super 8 pre-stripped film has two tracks. The GS-1200 STEREO uses Track 1 for the left channel and Track 2 for the right channel. Each channel has a pre-amp., main amp. and 12.5cm Dynamic Speaker for complete stereo performance. The basic function of the projector (ON/OFF, Forward/Reverse Run and Still) is controlled quickly and accurately by piano key type buttons, and all instruments related to the sound system are coordinately located for optimum simplicity. Left channel is controlled by instruments on the left/right channel by instruments on the right. You can operate the GS-1200 STEREO as easily as you do the ordinary sound projector. The GS-1200 STEREO helps you to enjoy real sound movie making.

# Checking the position of switches and knobs before projection

Check the position of switches and knobs before projection (reproduction).

1

Is the ESS switch at NORMAL position?

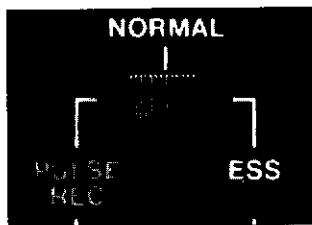

ESS switch

2

Is the speed selector at the proper position?

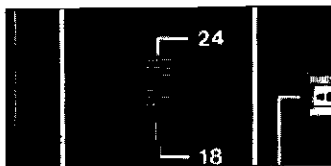

Speed selector

3

Is the speed knob in the middle?  
(Refer to the page 39.)



Speed knob

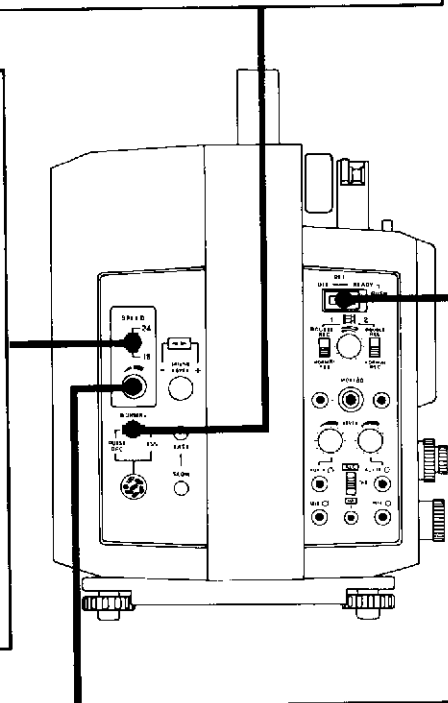

4

Is the spot recording button at OFF position?

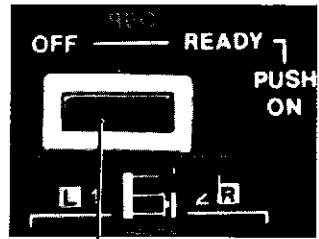

Spot recording button

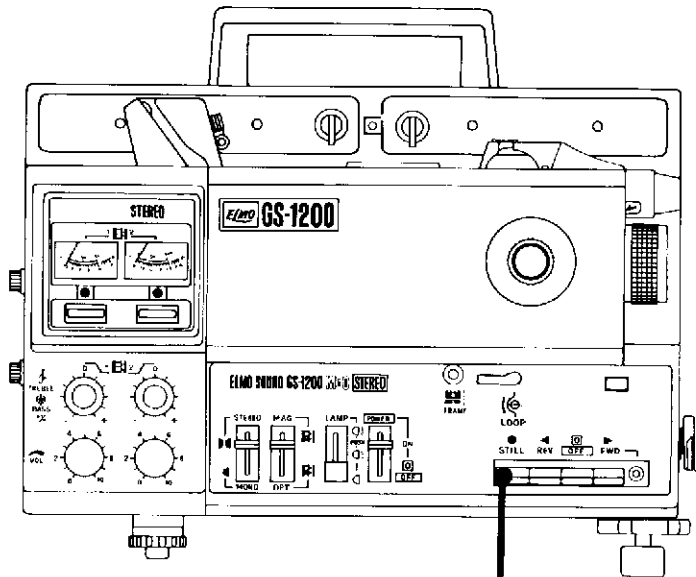

5

Is the still (STILL) button free?  
(Refer to the "Still projection" on  
page 16.)

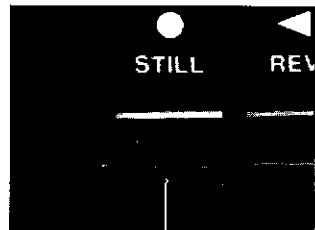

Still button

# Image adjustment

Adjust the screen image before threading a film.

**1** Plug in the power cord.

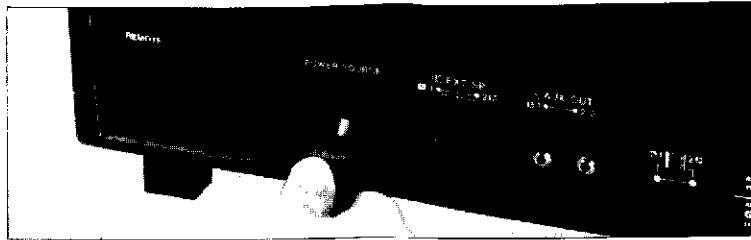

**2** Erect both arms into positions until they lock.  
(Depress arm locks to fold back.)

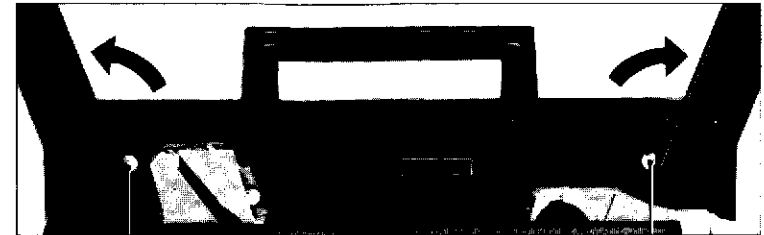

**3** Set the power switch to ON.  
(The fan motor runs.)

Note:  
Avoid to turn power switch on and off repeatedly so as to keep proper function of projector.

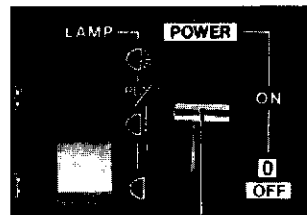

Power switch

**5** Set the lamp switch to .

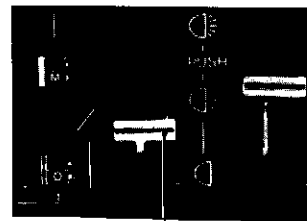

Lamp switch

**4** Push the forward (FWD) button.  
(The projector runs and the pilot lamp on the right glows green.)

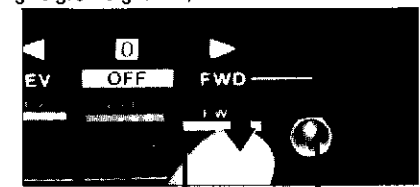

Forward button      Pilot lamp

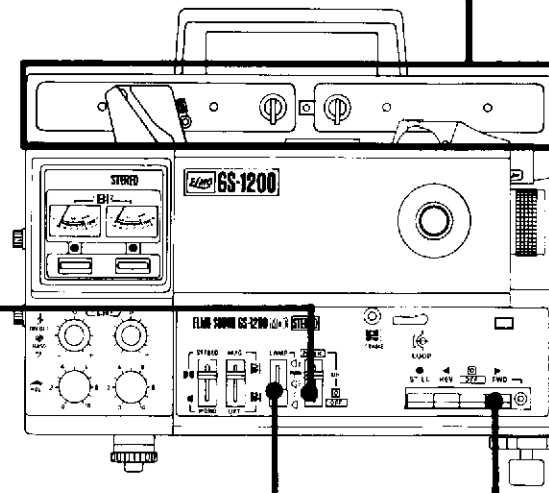

6

Adjust the height of picture with the elevation control knob.

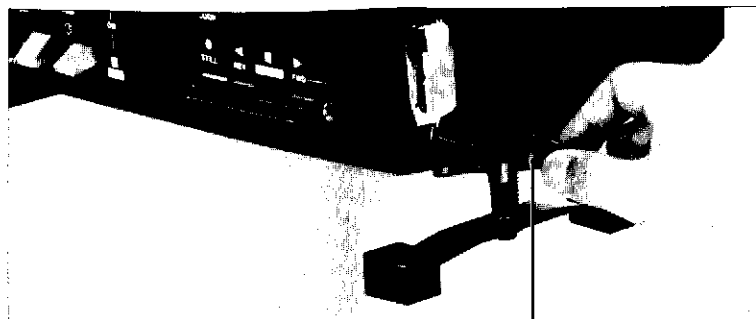

Elevation control knob

9

Adjust the focus with the focus knob.

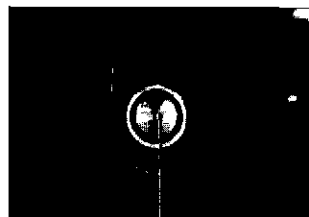

Focus knob

10

Set the lamp switch to  (OFF).

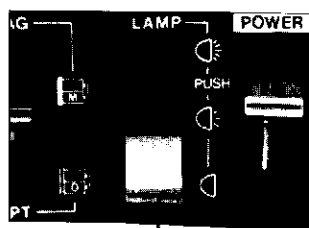

Lamp switch

7

Adjust the inclination with the image level knob.

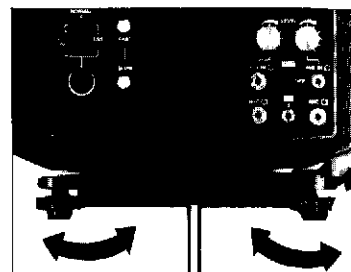

Image level knob

8

Adjust the picture size with the zoom ring.



Zoom ring

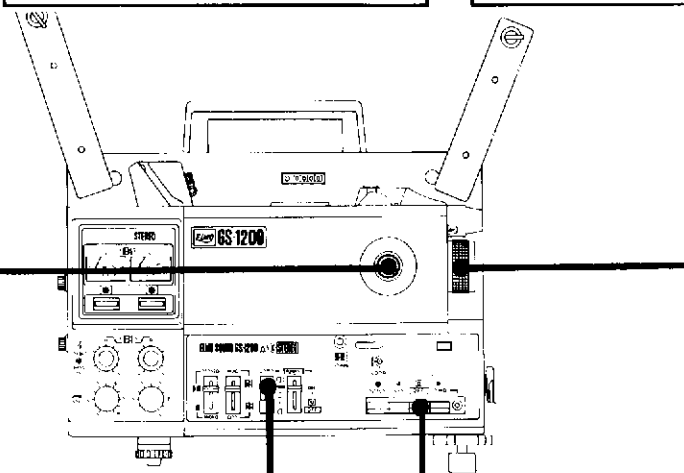

11

Push the off (OFF) button.

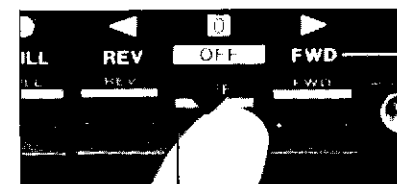

Off button



**1** Set the film guide in accordance with the capacity of the take-up reel.

When using 800ft reel



Film guide

When using 1200ft reel

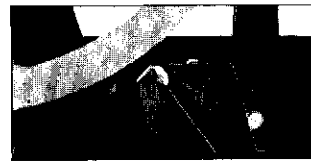
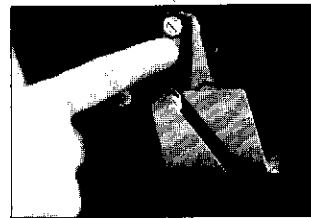

**3** Set the M-O selector to M (for magnetic sound film) or O (for optical sound film).  
When projecting the silent film, set the M-O selector to O and turn the volume control knob to 0.

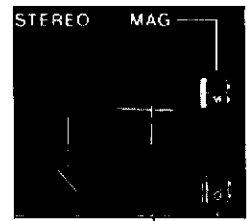

M-O selector

**4** Set the stereo-mono selector to STEREO or MONO in accordance with the sound film.

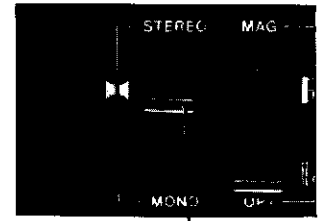

Stereo-mono selector

**2** Place your reel with film on the front arm and take-up reel on the rear arm.

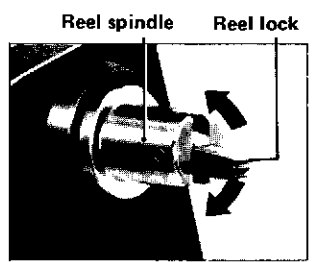

Note:

- 1. Press the reel locks until the reels are snugged against the spindles.
- 2. If take-up reel with a capacity less than 240m (800ft) is used, sound playback may be affected. Be sure to use the take-up reel supplied with the projector or 360m (1200ft) reel.

**5** Trim the end of the film leader with the film trimmer.

Note:

Locate a film perforation over the fixed pin and trim off the end of the film.

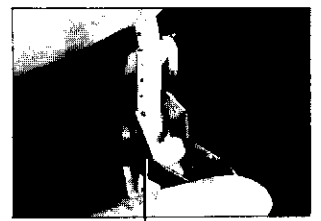
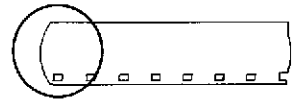

Film trimmer

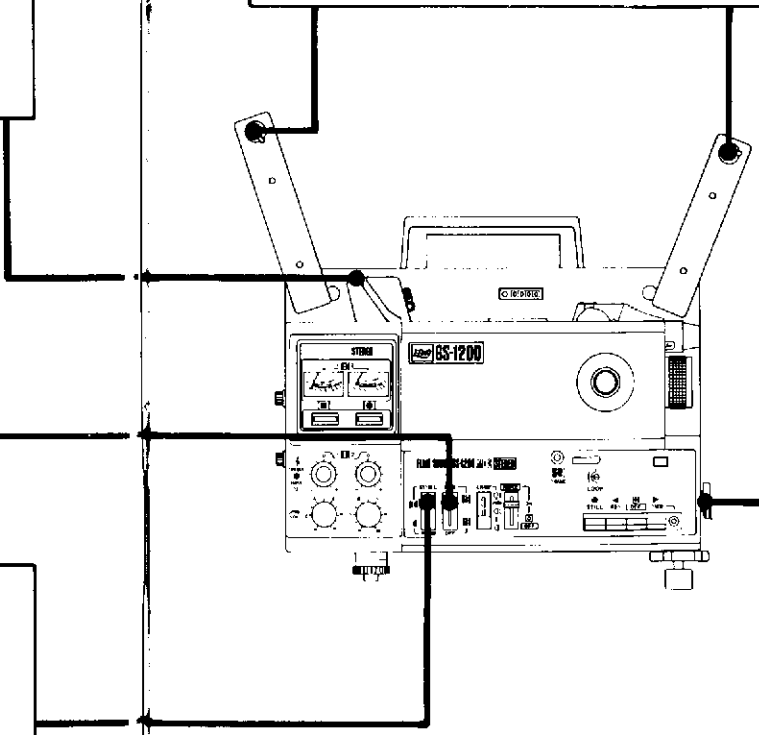

- 6 Depress auto thread lever until it locks. (Auto thread indicating lamp lights.)



Auto thread indicating lamp

Auto thread lever

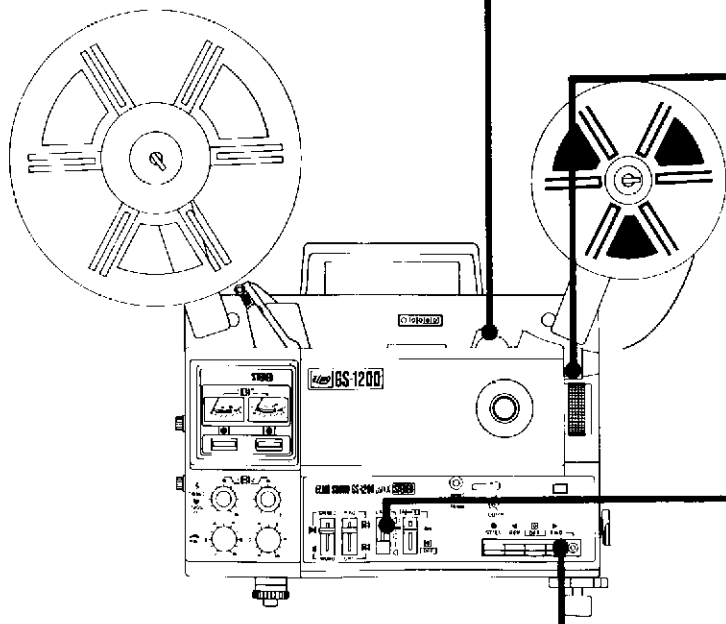

- 7 Push forward (FWD) button. (Green pilot lamp lights.)

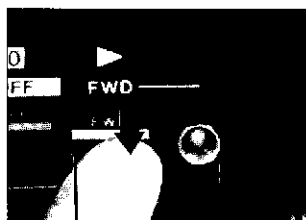

Forward button



Pilot lamp

- 8 Insert film leader into the auto thread slot as indicated by the red arrow. When film reaches the take-up reel, the auto thread lever will release automatically.

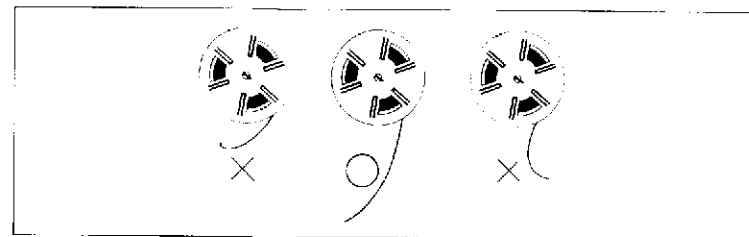

Film thread slot



- 9 Set the lamp switch to  position. If higher brilliance is required, advance lamp switch further to , while pushing it. The  position will extend lamp life.

**Note:**

The lamp will not light if the auto thread lever is not released. (The auto thread lever will release when film reaches the take-up reel. If not, turn the take-up reel clockwise by hand to release the auto thread lever manually.)

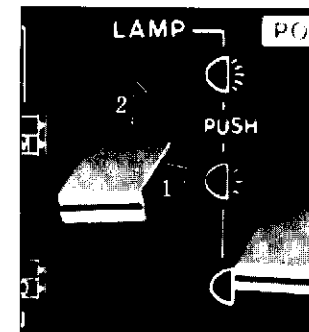

Lamp switch

**11**

If a frame line appears on the screen, eliminate frame line from the screen with framer.

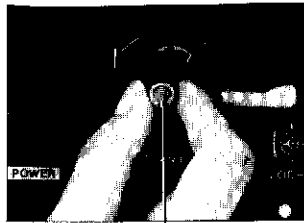
**Framer****12**

### Stereo sound reproduction

Adjust the playback levels of both tracks (1 and 2) by turning the volume control knobs for the left and right channel.

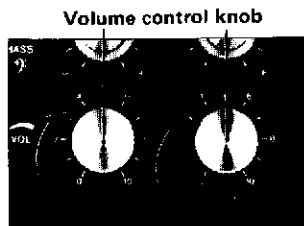
**Volume control knob**

### Monaural sound reproduction

Set the stereo-mono selector to mono-position.  
Adjust the playback level of track 1 by turning the volume control knob for left channel.  
At the same time, turn the volume control knob for right channel fully counterclockwise.

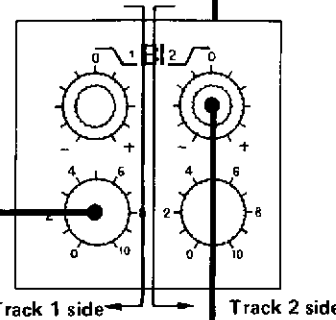
**Track 1 side****Track 2 side****13**

Adjust the tone by turning the treble and bass control knobs.

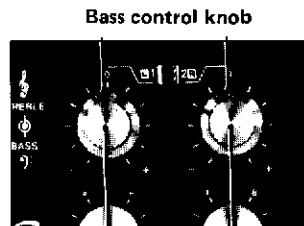
**Bass control knob****Treble control knob****10**

Adjust the sharpness of picture on the screen with the focus knob.

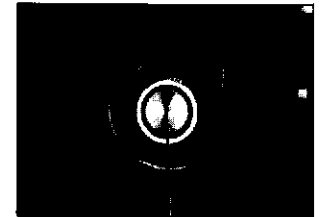
**Focus knob****14**

If film loop is lost during projection, press down the loop former.

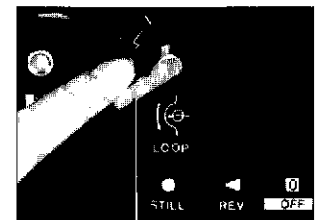
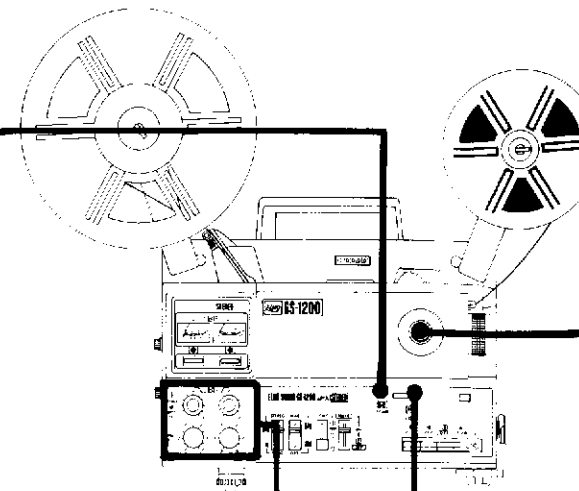
**Loop former**

## Reverse projection

Push the off (OFF) button to stop the projection once. Then push the reverse (REV) button for reverse projection. When changing the reverse projection to forward projection, push the off (OFF) button first, and push the forward (FWD) button.

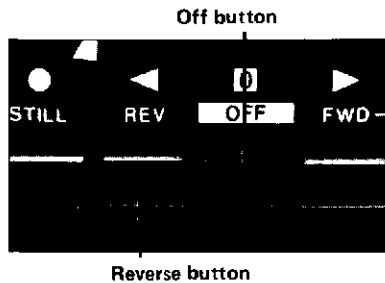

## Still projection

If you wish to show a particular frame during projection, push the still (STILL) button. (It locks automatically.)

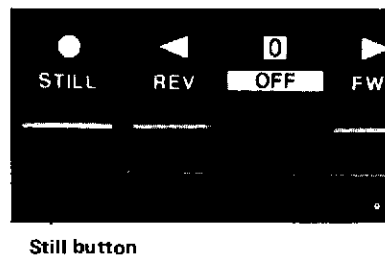

### Note:

If the film stops in the middle of a frame, or the aperture is closed, push either the forward (FWD) or the reverse (REV) button to get a full frame of picture on the screen.

## Releasing the still projection

To release the still projection, push the still (STILL) button again.

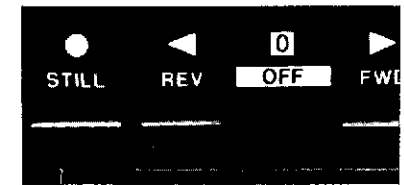

Still button

### Note:

1. As soon as the still button is released, the projector will automatically return to the original operation mode just before the still projection is started. For instance, if the still button is pushed during the regular forward projection at 18 fps, the projector will restart in forward direction at 18 fps when the still button is released. So it is not necessary to re-set the projector after the still projection.
2. If you want to stop the projector immediately after the still projection, push the still (STILL) button again, while depressing the off (OFF) button.

## Slow projection

If the forward (FWD) button is kept depressed after the still (STILL) button is pushed, the slow projection (Approx. 6 fps) is possible. If the reverse button is kept depressed, the reverse slow projection is possible.

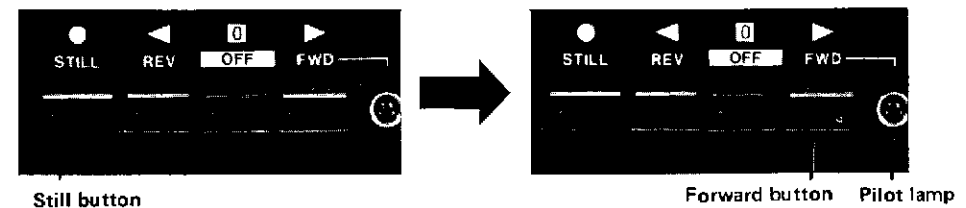

## Remote control projection

With the optional remote control unit, remote operation of projection and recording is possible.

- 1 Connect the remote control unit to the remote receptacle on the rear cover of projector.



Remote receptacle

- 2 Load film with the projector. Adjust the sharpness of picture on the screen and the sound level.

- 3 Set the power switch to ON.

- 4 Set the lamp switch to ☽ or ☼ position.

- 5 Be sure that the still (STILL) button is free.

- The following operation through the remote control unit is possible.

Forward projection: Push Forward (FWD) button on remote control unit.

Stop: Push Off (OFF) button on unit.

Reverse projection: Push Reverse (REV) button on unit.

Recording: Push Forward (FWD) button, depressing Recording (RECORD) button on unit.

Spot recording: Push Spot recording button, depressing Recording (RECORD) button on unit.

**Note:**

Slow projection through the remote control unit is not possible.

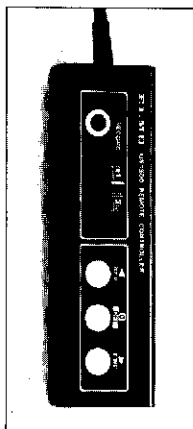

## Public address system

You can use the projector as a public address system.

1. Set the PA-ALC selector to the PA position.
2. Plug the microphone into the PA jack.
3. Turn the volume control knob for left channel (Track 1) to get proper volume. The public address system can also be used to speak over the playback sound during the projection.

**Note:**

1. When using your projector as a public address system, it is recommended to attach the extension speaker. However, be careful not to place the microphone too close to the speaker or adjust the volume too high which may result in an undesirable loud noise or howling.
2. When the M-O selector is set at the M position and the stereo-mono selector at the stereo position, the voice through public address system will be heard only from the left-channel (Track 1) speaker. When the M-O selector is set at the O position or the stereo-mono selector at the mono position, the voice through public address system will be heard from both left and right channel speakers.

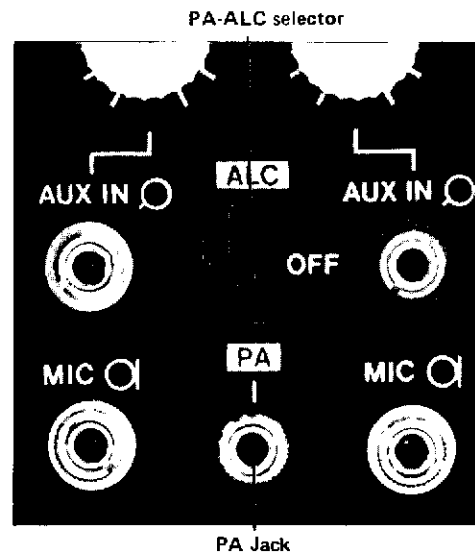
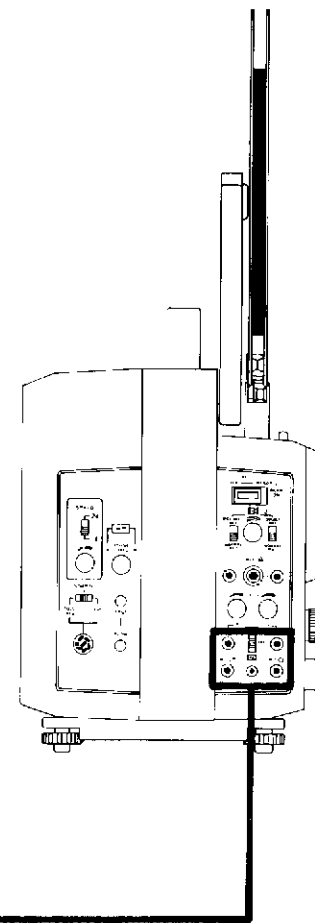

## Reproducing sound through a stereo set

Connect the AUX-OUT jack of the GS-1200 (on the rear cover) with the AUX-IN or PB (playback) jack on a stereo amp. by the accessory cord MC-006. (Connect the Track 1 AUX-OUT jack with left channel, and the Track 2 AUX-OUT jack with right channel.)

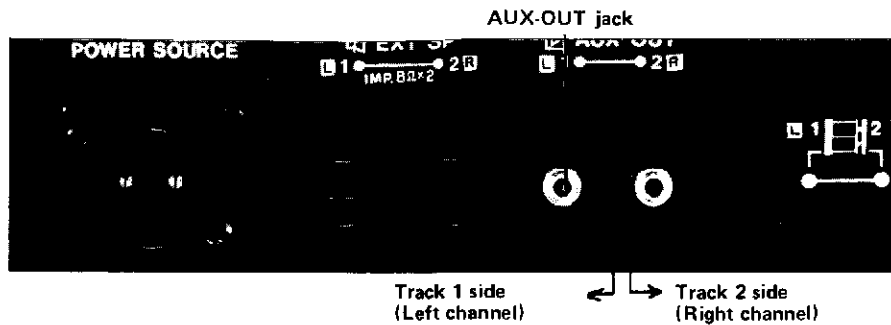

## Connecting the extension speakers

Connect the left channel speaker line to the EXT SP 1 connector, and the right channel speaker line to the EXT SP 2 connector.

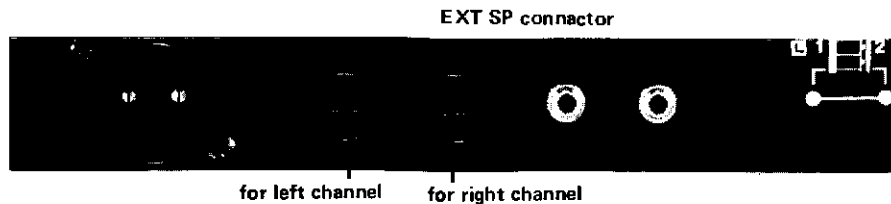

When using an extension speaker with a phone plug, use the accessory cord adaptor SC-002 for connecting its speaker line to the EXT SP connectors. Be sure to use speakers with an impedance rating of 8 ohms.



## Using the level meter during playback

The level meter can also be used to observe the output level at the AUX-OUT terminal.

### Note:

1. The level meter indicates the recording level of sound. Therefore, the indication of level meter is not affected even if the volume control knob is turned to adjust the loudness of playback sound.
2. When the level meter indicates 0 (100%), the output level at the AUX-OUT terminal is approximately  $600\Omega -10dBm$ .

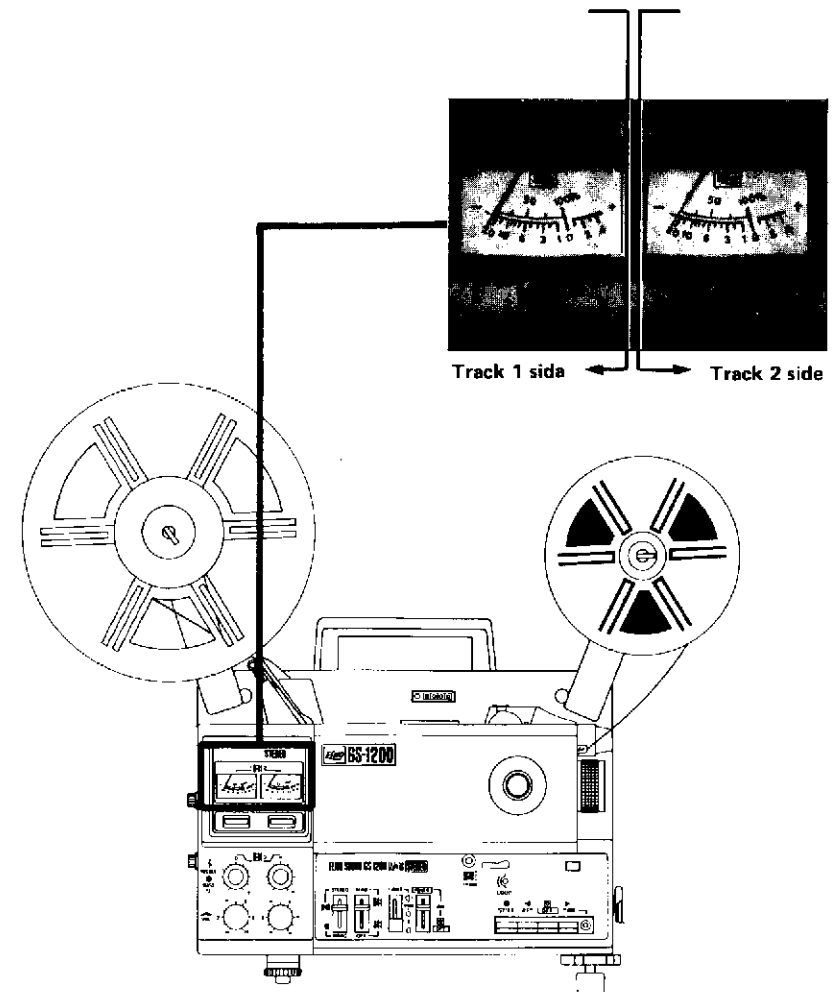

## Removing the film from the film path

- 1 Push the off (OFF) button to stop the projector.
- 2 Slide the power switch to OFF.
- 3 Open the front cover by pulling top toward yourself.

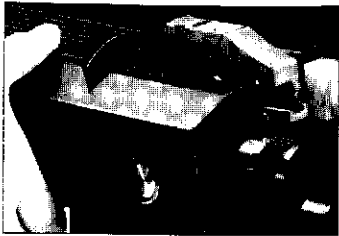

Front cover

- 4 Turn the take-up reel clockwise by hand to slack off the film.

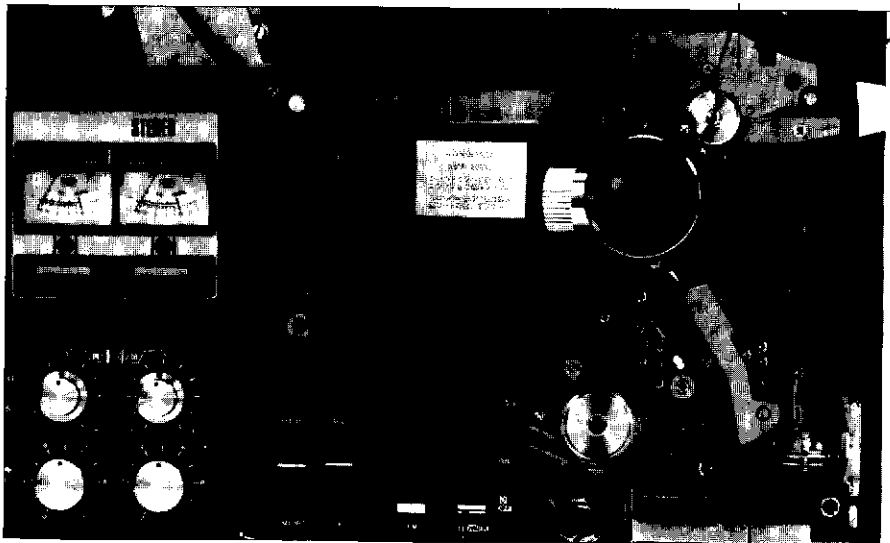

Power switch Second sprocket shoe Off button

- 5 Swing the lens away from the projector, holding the lens barrel.
- 6 Remove the film, depressing the second sprocket shoe.
- 7 Remove the film, pressing the first sprocket shoe upward.
- 8 Remove the film from the film path.

## Rewinding

- 1 Insert the end of the film into the slot of the feed reel hub.

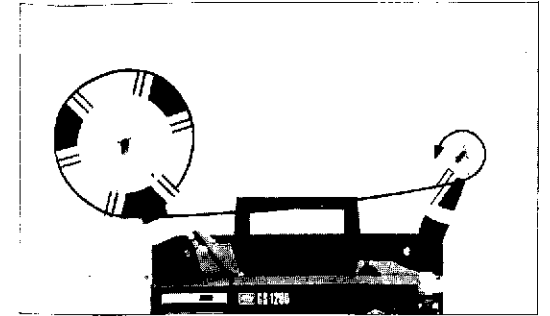

- 2 Pull out the rewind (REW) lever.



Rewind lever

- 3 After the film has been completely wound on the feed reel, push back the rewind (REW) lever.

### Note:

1. Even if you push the off (OFF) button, the projector will not stop while the rewind (REW) lever is pulled out.
2. Be careful not to touch the rewind lever during projection.

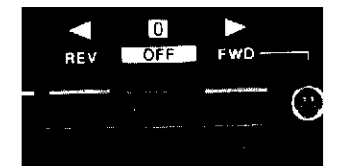

Off button

# Recording procedure

**1** Set the M-0 selector to M.

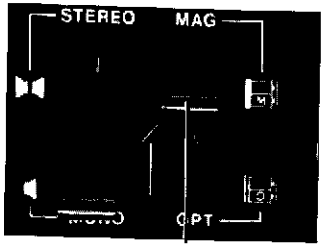

M-0 selector

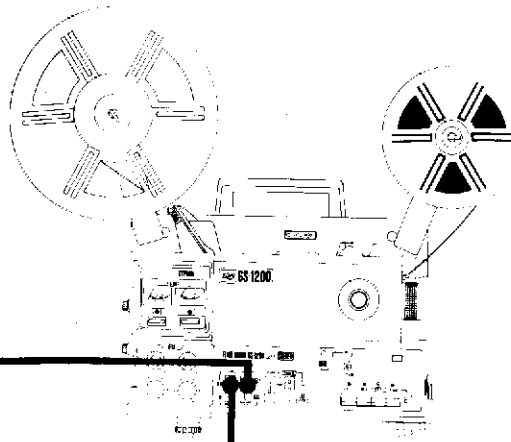

**2** Set the stereo-mono selector to STEREO.

**Note:**  
Always set to STEREO even when recording monaural sound.

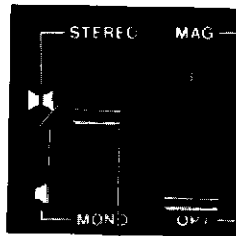

Stereo-Mono selector

**3** Set the ESS switch to NORMAL.

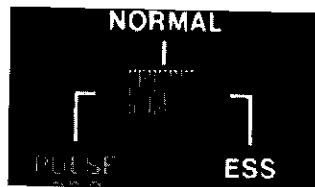

ESS switch

**4** Select proper projection speed, either 18 fps or 24 fps.

**Note:**  
Set the speed knob in the middle.

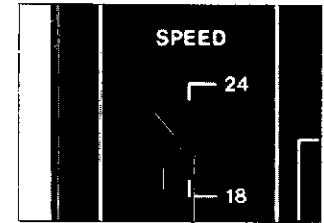

Speed selector

**5** Set the spot recording button to READY.

**Note:**  
Sound cannot be recorded if the spot recording button is set at OFF.



Spot recording button

**6** Set the double recording selectors of both Track 1 and 2 to NORMAL REC.

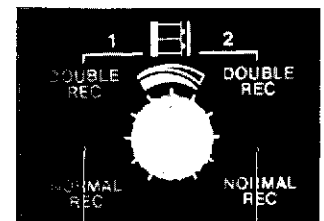

Double recording selector

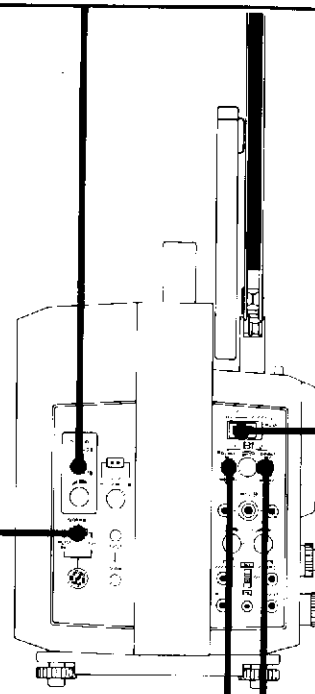



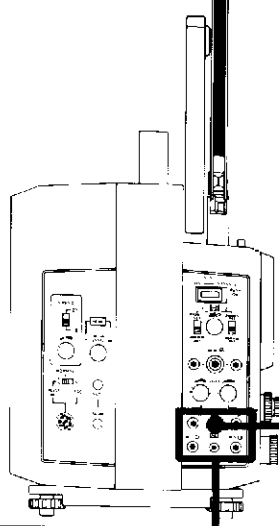

8

Connection of the input line.

- A. Connect the tape recorder/mixer to AUX-IN jack.

Note:

Use the MIC jack when output level of mixer is low.

- B. Connect the microphone to the MIC jack.

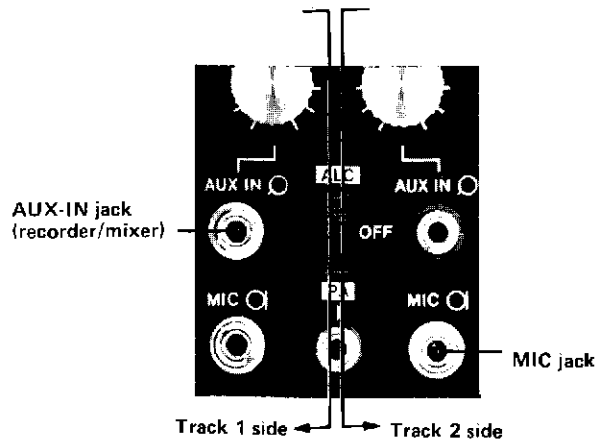

7

Set the PA-ALC selector either to ALC for automatic recording or to OFF for manual recording.

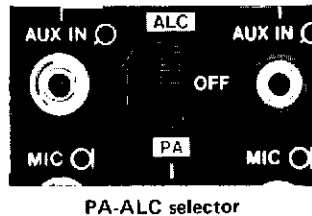

9

Recording level adjustment.

Note:

Make certain that the spot recording button is set at READY.

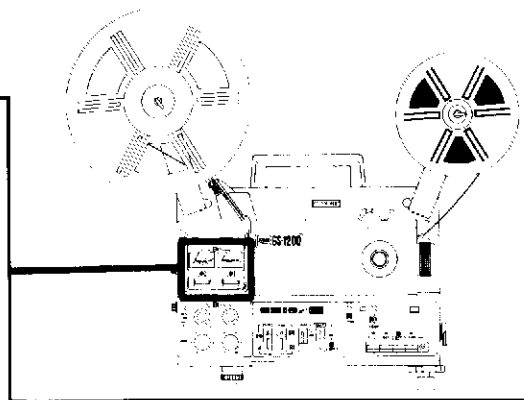

- A. Input the sound.
- B. Adjust the recording level while depressing the recording button.
  - a. Recording level setting.

\* ALC recording:

Once the recording level is adjusted with the AUX volume control knob or the main volume control knob so that the needle of level meter stays around "0" (100%) position, ALC circuit will automatically control the level to maintain optimum distortion-free recording.

\* Manual recording (ALC selector at OFF):

Adjust the level with the AUX volume control knob or the main volume control knob so that the needle of level meter swings to "0" (100%) position at maximum.

- b. The recording indicator lights when projector is set for recording.

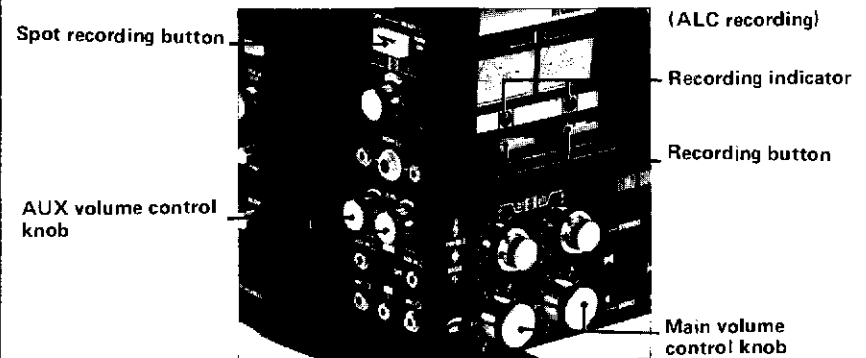

**10** Set up the start position of the tape.

**11** Load the film and start the projector.

A. As soon as the first frame appears on the screen, reset the film counter to zero by pressing the reset button.

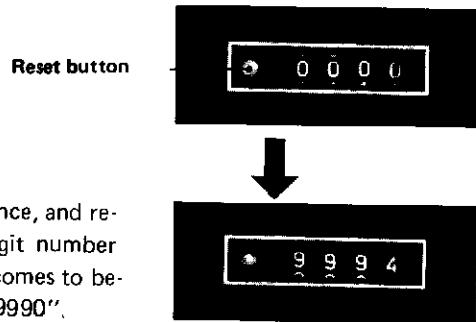

B. Stop the projector once, and reverse it until the digit number of the film counter comes to be between "9994" and "9990".

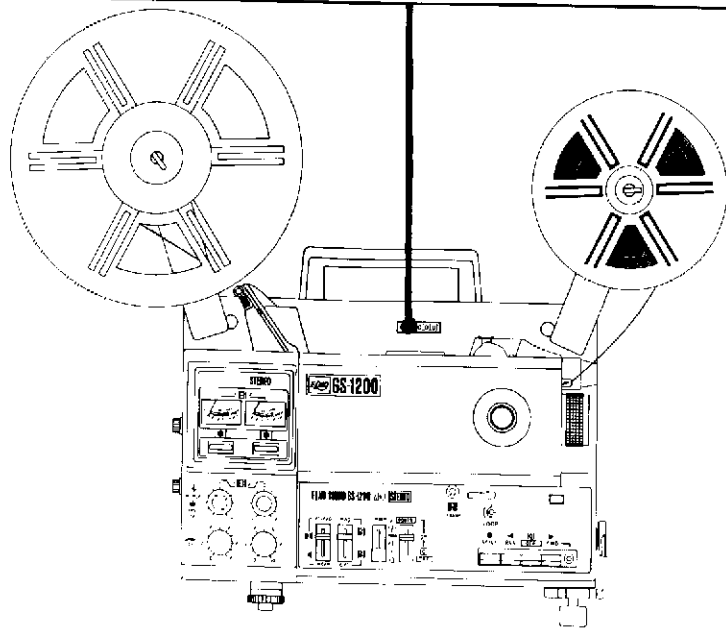

**12** While depressing the recording button, push the forward (FWD) button to start the projector.

**Note:**

After the projector starts running, release fingers from both buttons.

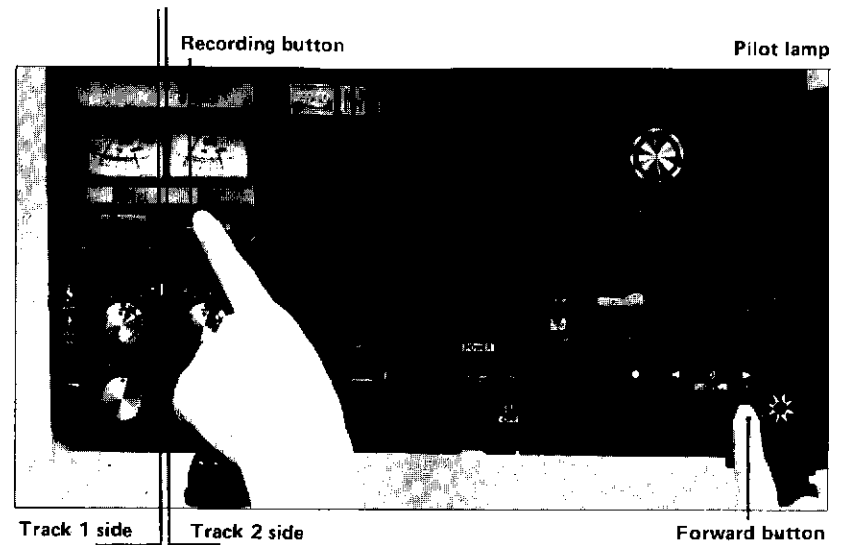

**13** Start the tape recorder just when the digit number of the film counter comes to "0000".

**14** Stopping the projector releases the recording facility. To discontinue the recording during projection, slide the spot recording button to OFF.

## Stereo recording

1 Use Track 1 for the left channel and Track 2 for the right channel.

2 Adjust the sound levels of both Tracks 1 and 2.

3 Start the projector while depressing both recording buttons 1 and 2.

**Note:**  
Make certain that both recording indicators 1 and 2 light.

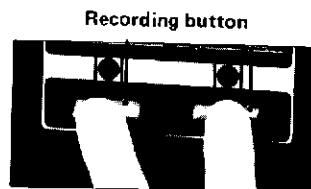

## Monaural recording

1 Generally use Track 1 for monaural recording.

2 See "Recording procedure" on page 26 for recording operation. Adjust the recording level with the AUX volume control knob or the main volume control knob of Track 1.

**Note:**  
Volume control knobs of Track 2 should be fully turned down.

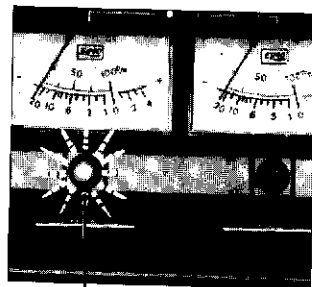

Recording indicator 1

3 Check that the recording indicator 1 lights during recording.

## Monitoring

A stereo headphone can be used to monitor the sound.

### Note:

When using earphones, monitor the sound on Track 1 through the left ear and on Track 2 through the right ear.

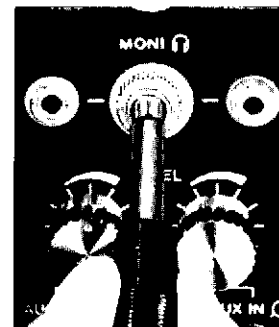

Stereo headphone jack

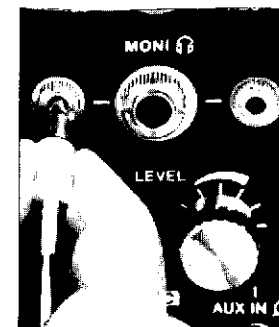

Earphone jack (left)

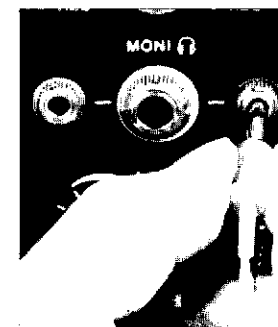

Earphone jack (right)

## Adding sound to simultaneously recorded film (Recording on Track 2)

With the sound camera, sound is simultaneously recorded on Track 1. Make recording (BGM/narration/sound effects) on Track 2 to accompany the original sound on Track 1.

1 As for the connection and controls, use those for Track 2 recording. (Shaded part in the illustration).

2 It is advisable to monitor the recorded sound on Track 1 through the headphone or earphones while recording sound on Track 2.

### Note:

Loudness of Track 1 sound being monitored through the headphone can be adjusted with the volume control knob 1.

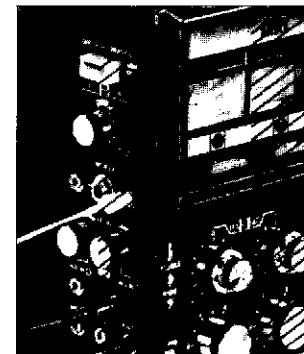

# Track to track sound transfer

- 1** To transfer sound from Track 1 to Track 2, connect the AUX-OUT jack of Track 1 to the AUX-IN jack of Track 2 with the connection cord MC-001.

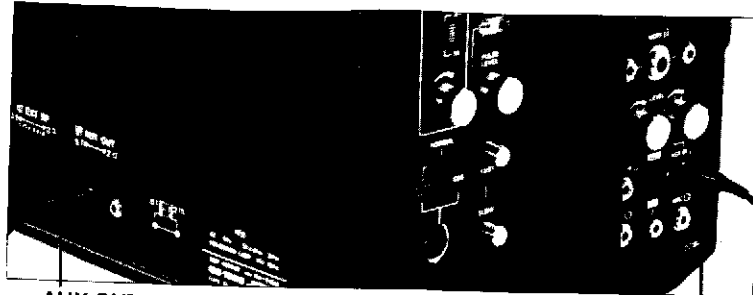

AUX-OUT jack  
Track 1 side

AUX-IN jack  
Track 2 side

- 2** Set the controls of Track 2 to the recording mode, and start the projector. Adjust the recording level with the AUX volume control knob of Track 2, and transfer sound from Track 1 to Track 2.

**Note:**

1. When the AUX volume control knob 2 is turned too far, undesirable self oscillation may occur. (In this case, level meter swings extremely to the RH end of meter range.) Adjust the AUX volume so that the self oscillation will not occur.
2. The recording level can be checked by monitoring the sound being recorded on Track 2. The sound being transferred, whose loudness is adjustable with the volume control knob 1, can also be monitored.

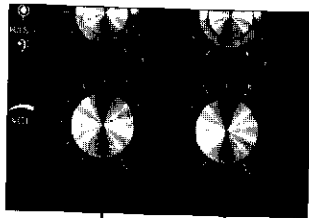

Volume control knob  
Track 1 side

Volume control knob  
Track 2 side

- 3** To transfer sound from Track 2 to Track 1, connect AUX-OUT jack of Track 2 to AUX-IN jack of Track 1 with the connection cord MC-001. Use the controls for Track 1.

- 4** Elmo 4-channel mixer, MX-4 (option) is convenient for mixing sound during track to track sound transfer.

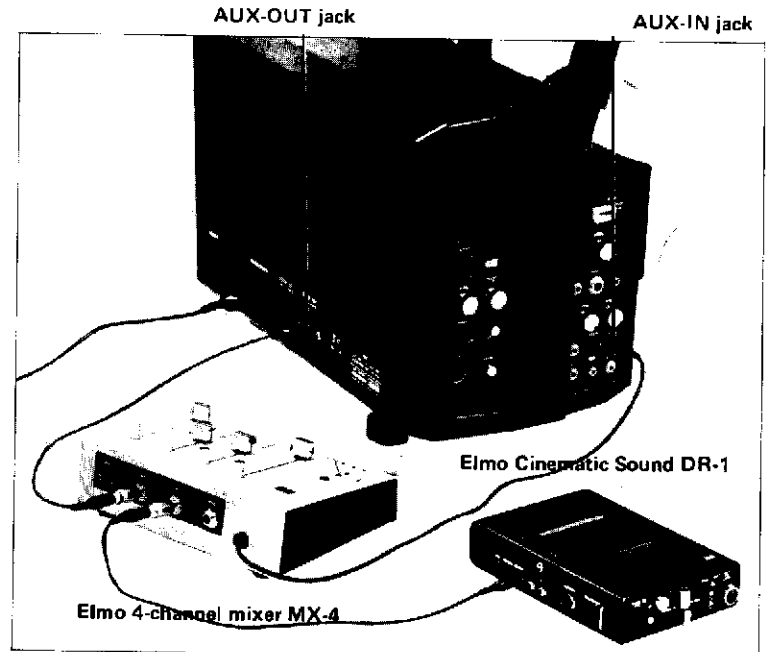

(Mixer connection during transferring sound from Track 2 to Track 1)

## Spot recording

To make spot recording without stopping the projector, depress the recording button together with the spot recording button.

### Note:

1. The recording indicator lights when the recording circuit is on.
2. Make certain that the spot recording button is set at READY.

Spot recording button      Recording button      Recording indicator

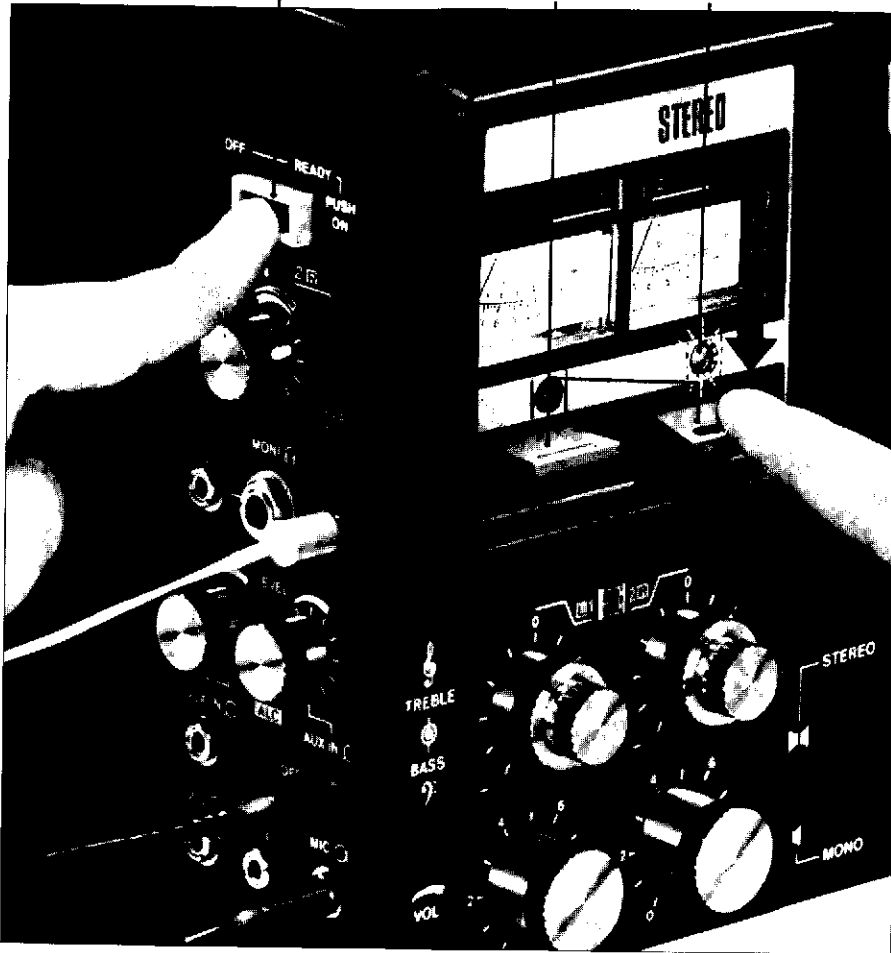

## Double (Sound on Sound) recording

Sound can be added over the recorded track without erasing the original sound.

1. Set the double recording selector of the track, to which you want to add new sound, to DOUBLE REC.

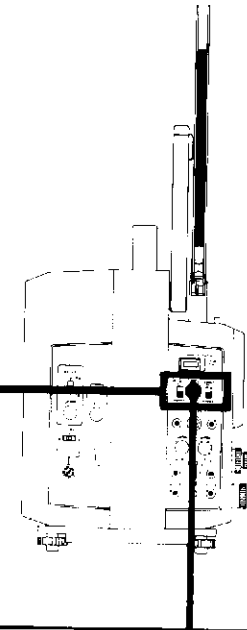
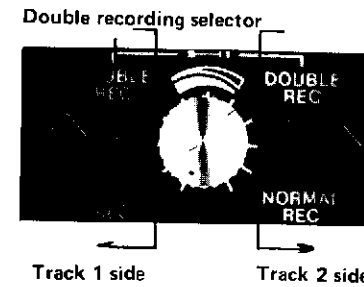

2. Turn the double recording control knob fully counterclockwise.

### Note:

With the knob set at this position, new sound is not recorded and the original sound is not affected.

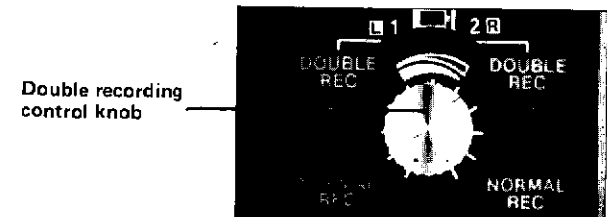

## Projection speed adjustment during recording

- 3** Start the projector while depressing the recording button of the track to be recorded over.

- 4** By slowly turning the double recording control knob clockwise, the added sound will gradually dominate the original sound. At the knob turned fully clockwise, the original sound is mostly erased, and, to the listener, it will seem the original sound has dissolved into the newly added sound. (To erase the original sound completely, set the double recording selector to **NORMAL REC.**)  
Slowly turning the double recording control knob from this position will gradually reduce the added sound with the original sound again dominating the track. This time it seems the added sound has dissolved back into the original sound.

**Note:**

1. When the double recording is finished, set the double recording selector to **NORMAL REC.**
2. In case of double recording, the clearness of the original sound may be affected.

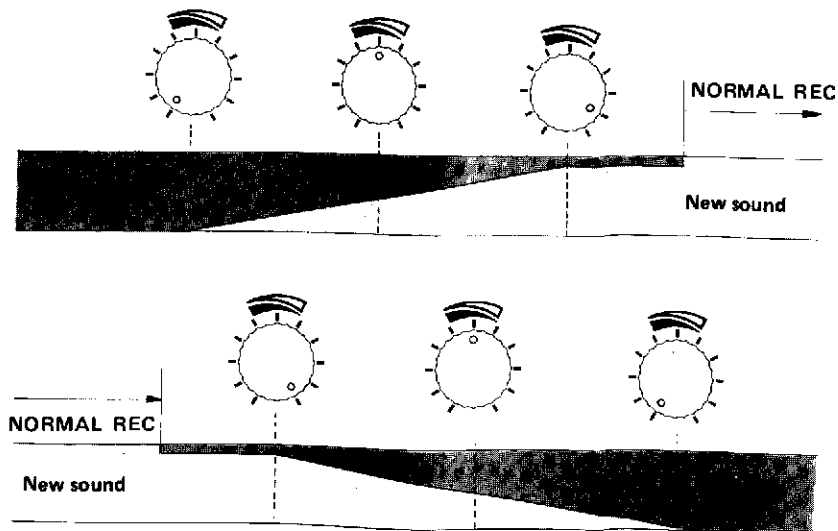

- 1** When transferring the sound, which was recorded with an independent tape recorder while filming or programed in conformity with every scene of movies, from the tape recorder to sound track of film, the sound to be recorded may sometimes not accord with the scene of movies as programed because of the fluctuation in running speed of tape recorder or projector.

- 2** In the above case, turn the speed knob of the projector so that the sound meets the scene.

**Note:**

Projection speed can be adjusted within  $\pm 1$  frame at 18 fps and within  $\pm 2$  frames at 24 fps.

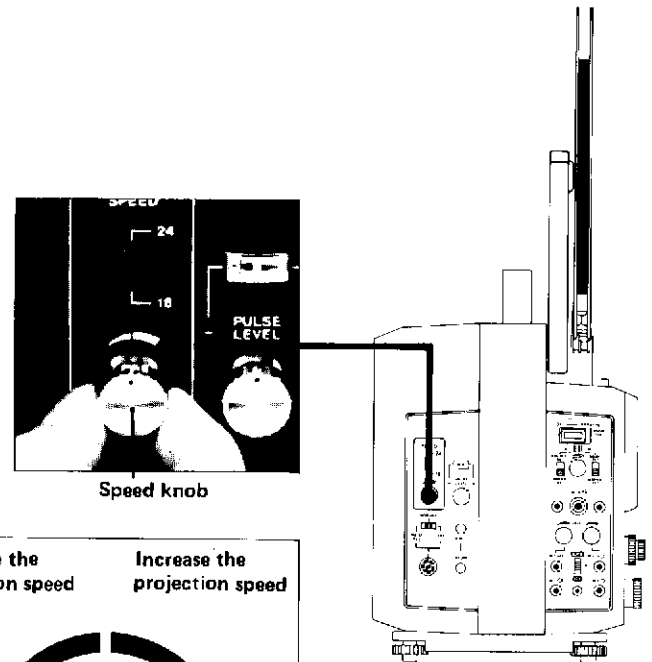

# Pulse-sync projection

This refers to the synchronized projection of the film taken with the pulse-sync cameras (Elmo 612R, 1018R and 110R Cameras) and the cassette tape recorded with Elmo DR-1 or SR-1, or the synchronized projection using Elmo Synchro-Sound SA-1 with an open tape recorder.

**1** Connect a tape recorder to the GS-1200 with the Pulse Cord PC-001.

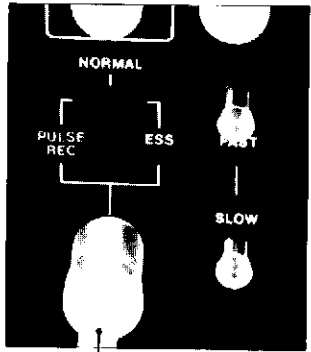

Pulse Cord PC-001

**2** Set the tape in the tape recorder.

**3** Load the film.

**Note:**  
The ESS switch must be at the position of the ordinary projection (NORMAL).

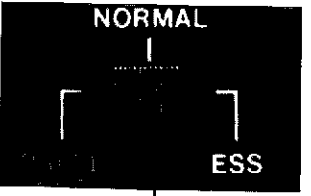

ESS switch

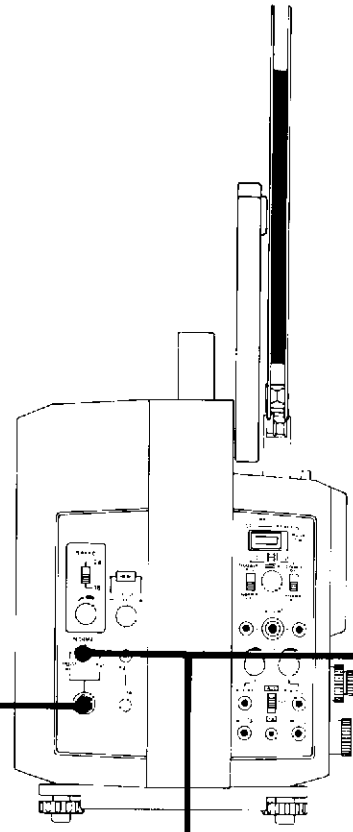

**4**



Locating the start of the film.

- a) The first frame of the intended projection scene should be adjusted to stay over the aperture mask.
- b) For easy adjustment, use the built-in film counter and the slow projection feature.

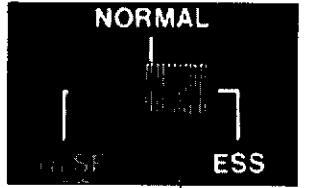
**5** Slide the ESS switch to the right for Pulse-Sync projection (ESS projection).



ESS switch

- 6 The lamp switch should be preset either at  or  position.

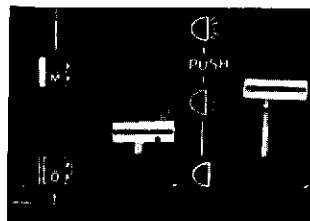

Lamp switch

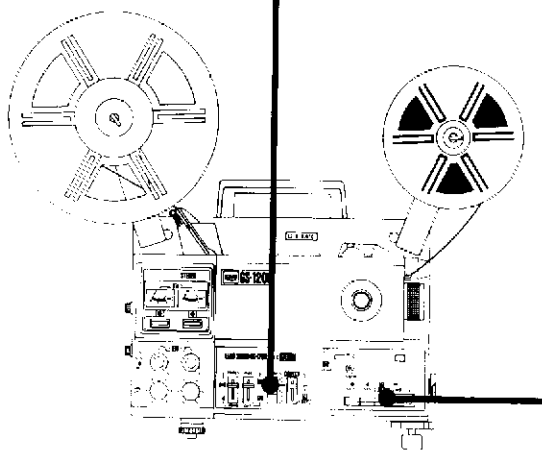

- 7 Depress the forward (FWD) button. (The green pilot lamp beside the key will light but the projector will not run because the projector is subject to the control of the pulse from the tape.)

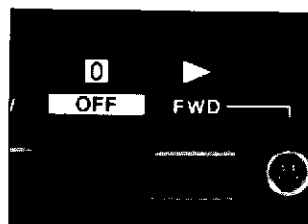

Forward button

- 8 Start the tape recorder. The projector will automatically start running with the pulse recorded on tape.

- 9 When the projector starts running, turn the pulse adjusting knob so that the indication needle of the pulse meter will stay in the middle.

Pulse meter

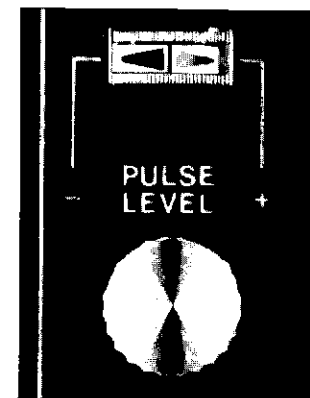

Pulse-adjusting knob

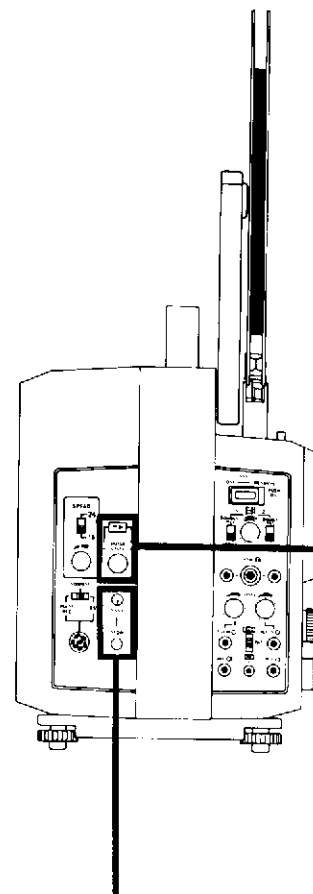

- 10 When the synchronization goes out of phase by any chance, correction can be done with fast/slow buttons. The projector will run faster while the fast button is depressed and it runs slower when the slow button is depressed.

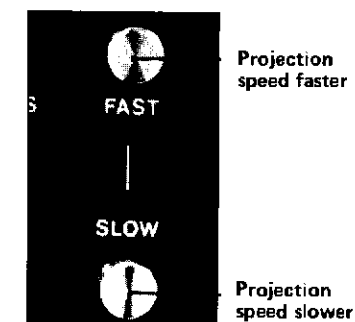

Sync correction buttons



## How to transfer the pulse system sync-sound to the sound stripe

You can directly transfer the pulse system sync-sound recorded on tape to the sound stripe of the film.

Establish connection between AUX-OUT of the tape recorder and AUX-IN of the GS-1200.

Set the projector for recording and do pulse sync projection.

- Of course, the film must have sound stripes.
- Recording procedures are the same as the normal recording.

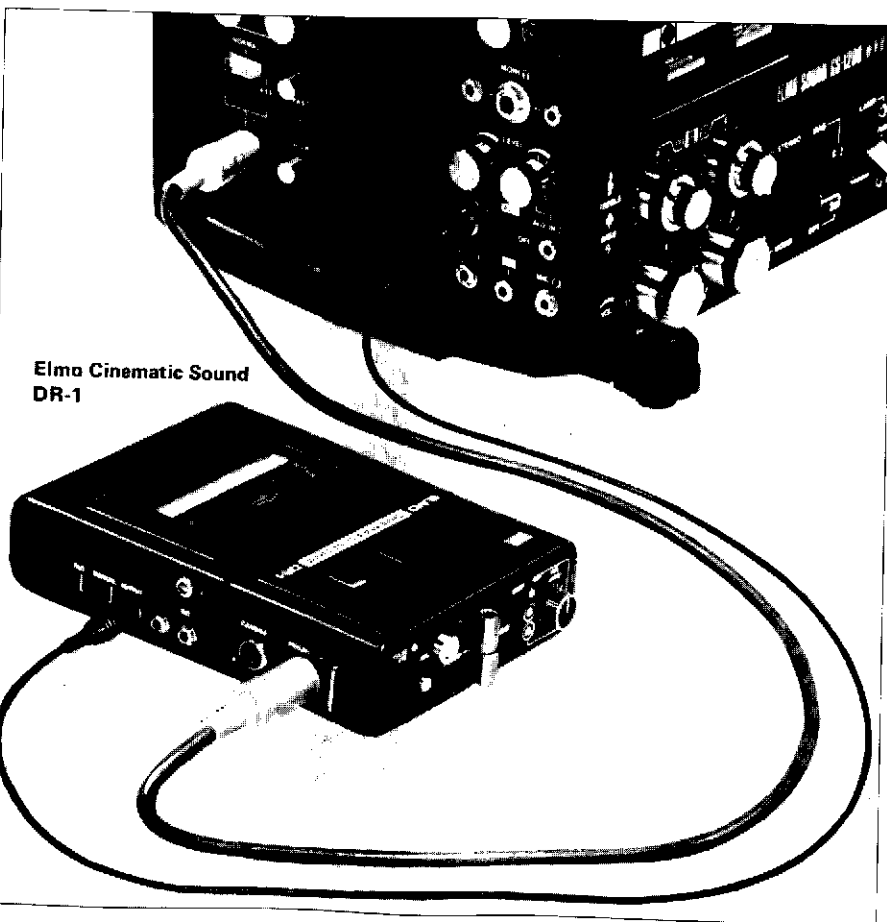

## Pulse recording

This refers to the method to make a pulse system synchronized tape. (Use Elmo Cassette Tape Recorders, Model DR-1 or SR-1, or any types of open tape recorders with Elmo Syncro Sound SA-1.)

**1** Connect a tape recorder to the GS-1200 with the Pulse Cord PC-001.

**2** Set the tape in the tape recorder.

**3** Adjust the first frame of the film over the aperture mask.

**4** Slide the ESS switch to the left, PULSE REC.

**5** Start the tape recorder.

**Note:**

For operation of the tape recorder or ESS SA-1 for pulse recording, please refer to the respective instruction booklets.

**6** Start the projector. When the projection is completed, stop the projector.

**7** Stop the tape recorder.

Now the tape has the necessary pulse. All you need now is to run the projector and the tape recorder, following the instructions for pulse-sync projection.

The projector will start running automatically with the pulse from the tape. Record narration or music, watching scenes.

## Cleaning

To get optimum performance, regular cleaning is vital. When cleaning, be sure to disconnect the power cord.

- 1 Pull the top of the front cover toward you to open.

Front cover

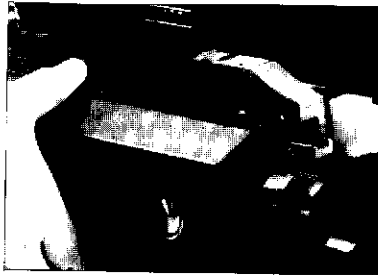

- 2 Swing the lens away from the projector.



- 3 Gently clean the aperture and pressure plates with the brushes provided or use a soft lint-free cloth. Dust which adheres to the magnetic head surface may affect recording/playback performance. So clean the head surface gently with a cleaning stick or soft cloth. When cleaning the head, make sure to disconnect the power cord and to set the motor switch at OFF.

Pressure plate



Aperture plate

Be careful not to touch the film claw or scratch the film path during cleaning. The film gate and path, which are in continuous contact with the film, are precisely machined to prevent damage to the film.

## Replacing projection lamp

Disconnect the power cord and be sure the lamp cooled sufficiently before handling.

The projection lamp is a 24V-200W Halogen Lamp with a dichroic mirror. (ANSI Code ESC or equivalent)

- 1 Loosen the screw at the left hand side to remove the cover.

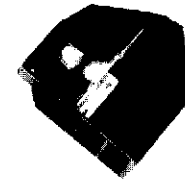

Note:  
The left half of the lamp cover is designed to accommodate a spare lamp.

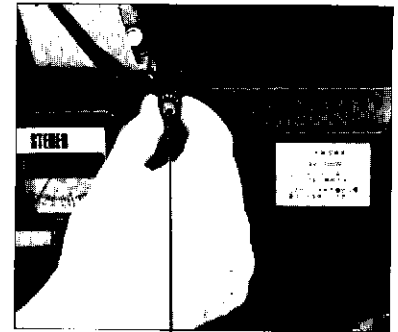

Lamp cover screw

- 2 Swing up the lamp ejector and the lamp will come away from the socket.

Note:  
When replacing the lamp in a hurry during projection, be careful as the lamp could still be hot.

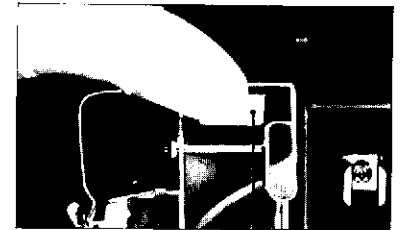

Lamp ejector

- 3 Push the lamp into the socket and close the ejector.

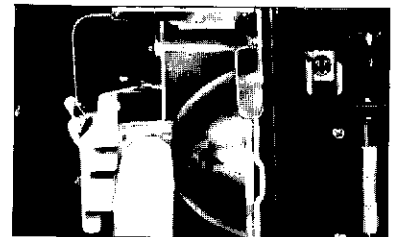

## Replacing exciter lamp

Disconnect the power cord.

Exciter lamp (4V-0.75A), type KE-02 or ANSI Code BRS should be used.

1. To remove, turn the lamp counterclockwise.

2. To install a new lamp, align the holes of the lamp fringe with the three guide pins of the socket. The notch on the fringe should face forward.

Turn the lamp clockwise until it stops.

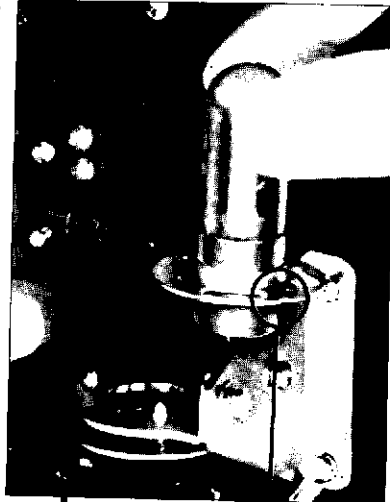

Notch

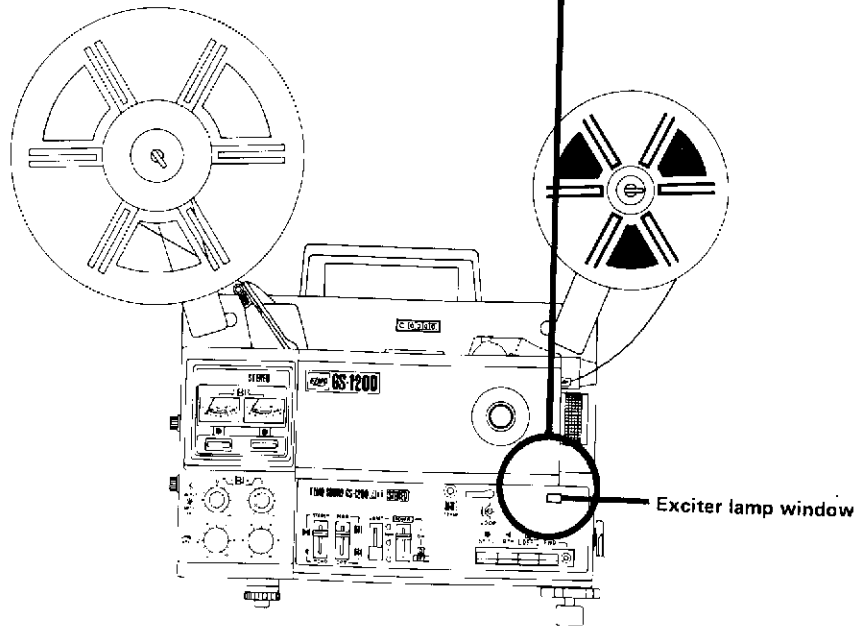

## Changing the projection lens

1 Turn the focus knob fully clockwise, and pull out the lens gently.



Focus knob

2 Turn the focus knob fully clockwise. While pulling focus knob towards you, insert the lens barrel into the sleeve until the lens is all the way in.

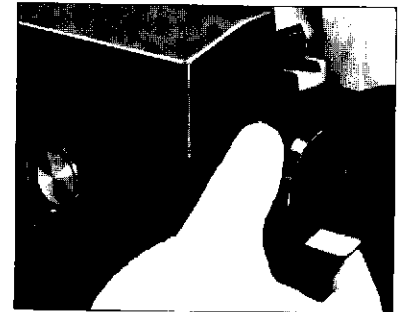

## Voltage selection

Voltage can be adjusted to comply with electrical requirements of each country. (There is a single voltage model that complies with the electrical regulations or conditions of each country.)

To American customers:

The projectors sold in the U.S. are designed for voltage alteration in the event that they are used in a foreign country. However, the projectors shipped from the factory are set for 115V AC operation and no alteration is needed when used in the U.S. If voltage alteration is necessary, please have it done by a qualified service personnel in order to prevent possible risk of electric shock.

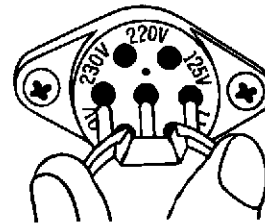

To service man:

- 1) Disconnect power cord.
- 2) Loosen screws and remove rear cover.
- 3) Pull out the voltage selection plug. Align the notch to the required voltage and then insert the plug back into the socket so the voltage can be read through the notch.

## Trouble-shooting hints



### ■ Motor does not run

1. Is the power cord properly plugged in?
2. Is the power switch on?
3. Is the ESS switch at NORMAL position?
4. Is the still button released?

### ■ Film does not thread properly

1. Is film leader correctly trimmed?
2. Isn't film extremely curled?
3. Is the auto thread lever set?

### ■ Projection lamp does not come on

1. Is the auto thread lever free?
2. Is the lamp switch either  or  position?
3. Isn't the lamp itself defective?

### ■ The auto thread lever is pushed by mistake

Load the film in the projector once. (When the lever is not released even when the film reaches the take-up reel, turn the take-up reel clockwise by hand slightly.)

### ■ Recording is not possible

1. Is M-0 selector at M position?
2. Is spot recording button at READY position?
3. Is double recording selector at NORMAL position?

### ■ Playback is not possible

1. Is M-0 selector at proper position?
2. Isn't volume control knob turned fully counterclockwise?
3. Isn't the exciter lamp for optical reproduction broken?

### ■ Stereo effect in playback is hardly obtained

1. Is the stereo-mono selector at STEREO position?
2. Is volume control knob turned properly?
3. Is the connection of the extension speakers for the R channel and L channel correct?
4. Is the film a stereophonically recorded one?
5. Are the extension speakers connected at the proper polarity?

### ■ 24 fps projection is not possible

Is the ESS switch at NORMAL position?  
(When the ESS switch is at the PULSE REC position, the projector will always run at 18 fps.)

### ■ The front reel (the spindle of front arm) does not stop rotating

Isn't the rewind lever pulled?

After checking the above items, if your trouble still persists, consult your nearest photo dealer or an authorized Elmo Service Centre.

## Optional accessories

### ● Elmo Viewer type 100

With the viewer type 100, you can show your films under daylight conditions. Use the GS-1200 adapter to attach viewer to your projector.

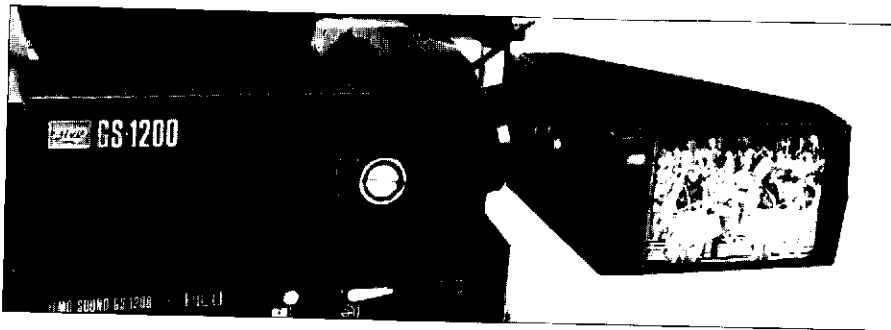
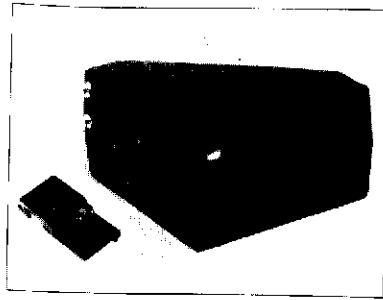

### ● Twin 2-way speakers

High performance extension speakers with a 10" (25cm) woofer and a horn type tweeter. Especially suitable for projection in a large auditorium. Stores conveniently in one portable case.

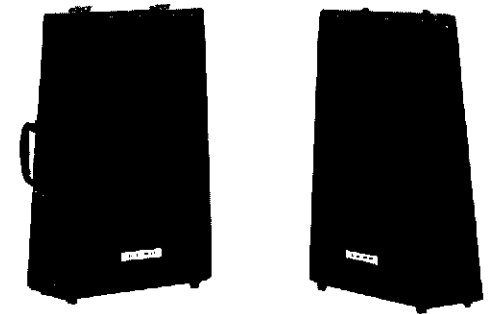
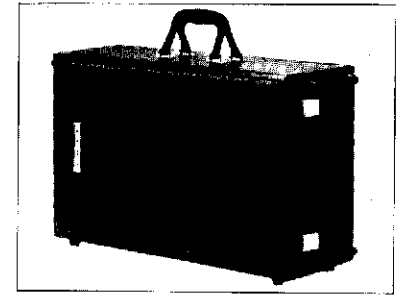

### ● Long-focus zoom lens

Sharp F1.4, 25 - 50 mm long-focus zoom lens for projection in a large auditorium.

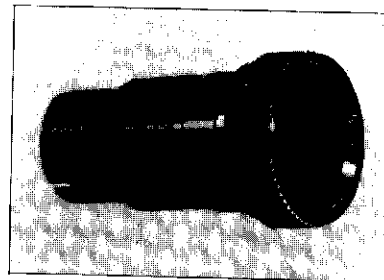

### ● 4-channel mixer MX-4

For mixing sound from four separate sources onto one track.

With this mixer you can perform professional fade-in, fade-out and overlapping.

Easily connects to tape recorder, record player and microphone.

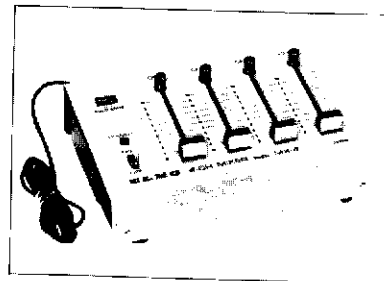

### ● Extension speaker ES-650

High-fidelity speaker mounted in wooden cabinet.

Rated input: 10W (max. 20W)

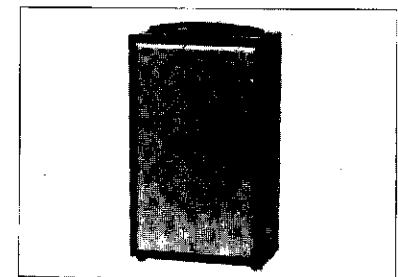

● **1200ft (360m) reel**

The largest reel capacity in the 8mm world. Enables continuous projection extended over one hour.

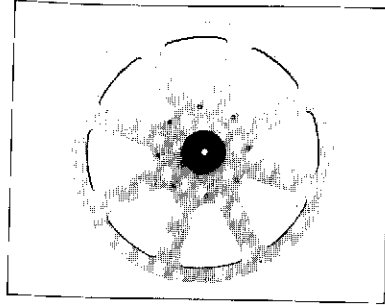

● **Editor 912**

Accepts both Super 8 and Regular 8 film. Includes sound monitor, film counter and film cleaner as optional attachments. An easy-to-handle, quality editor with a large, bright screen for producing fine sound or silent film.

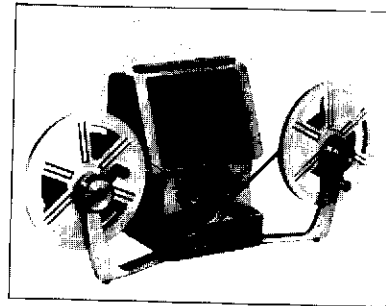

● **Daylight projection mirror**

This accessory mirror provides a clear projection image under daylight conditions when used with the special Elmo translucent rear projection screens.

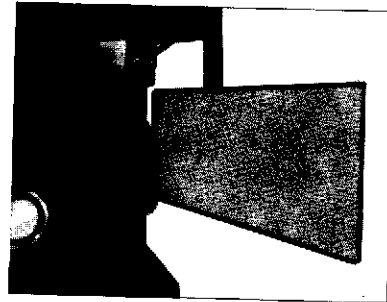

● **Translucent screens**

60 cm x 80 cm (23.6" x 31.5")  
39 cm x 52 cm (15.4" x 20.5")  
Special quality screens for rear projection under daylight condition.

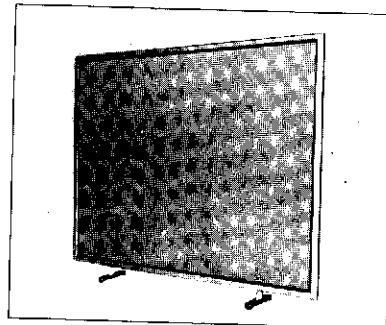

● **Continuous loop projection device EF-400**

No rewinding necessary. When attached to your GS-1200 projector, EF-400 provides fully automatic and continuous projection. Equipped with loop-sensor and auto-stopper to automatically stop projection if the film breaks. Accepts up to 400ft (120m) of film.

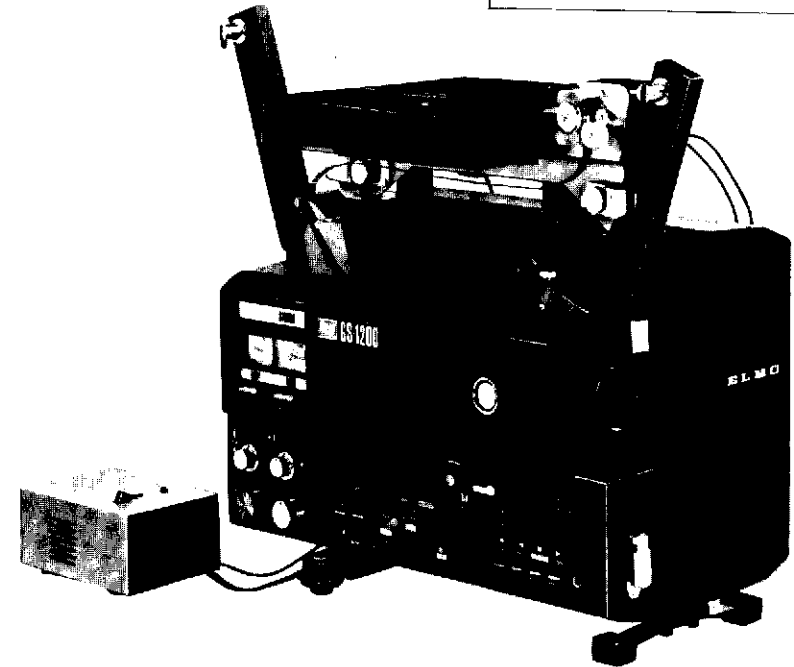
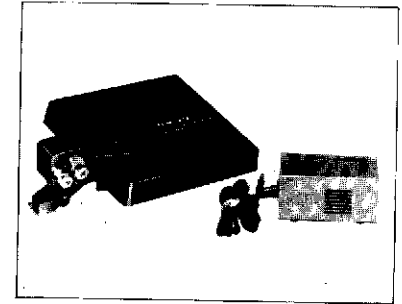

● **Elmo rewinders**

Large reel capacity-1200ft (360m). Fast winding. One rotation of crank turns reel three times.

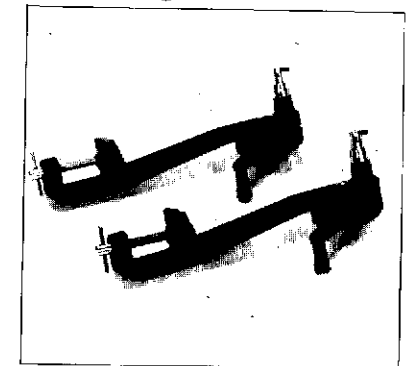

# Accessory cords

	Code No.	Specifications	Remarks	
Connection cord	MC-001	3.5φ 1.5m 3.5φ	1.5 m	
	MC-002	6φ 1.5m 6φ	1.5 m	
	MC-003	1.5m 3.5φ	1.5 m	
	MC-004	clip 1.5m	1.5 m	
	MC-008	1.5m 3.5φ	1.5 m	
	MC-009	3.5φ 1.0m 3.5φ	1.0 mm From earphone or monitor jack to AUX IN input	
	MC-010	3.5φ GREY 3.5φ	From earphone or monitor jack to MIC input	
	MC-017	3.5φ (Female) 3.5φ	Connection of green monitor jack and AUX IN jack	
	Adaptor	MP-001	3.5φ (Female) 6φ	
		MP-002	6φ 3.5φ (Female)	
Speaker cord	SC-002	10cm 6φ (Female)	10 cm For ST-800, ST-1200D, ST-1200HD, GS-1200	
Pulse (projection) cord	PC-001	1.2m	Pulse-sync cord (projection)	

# Block diagram

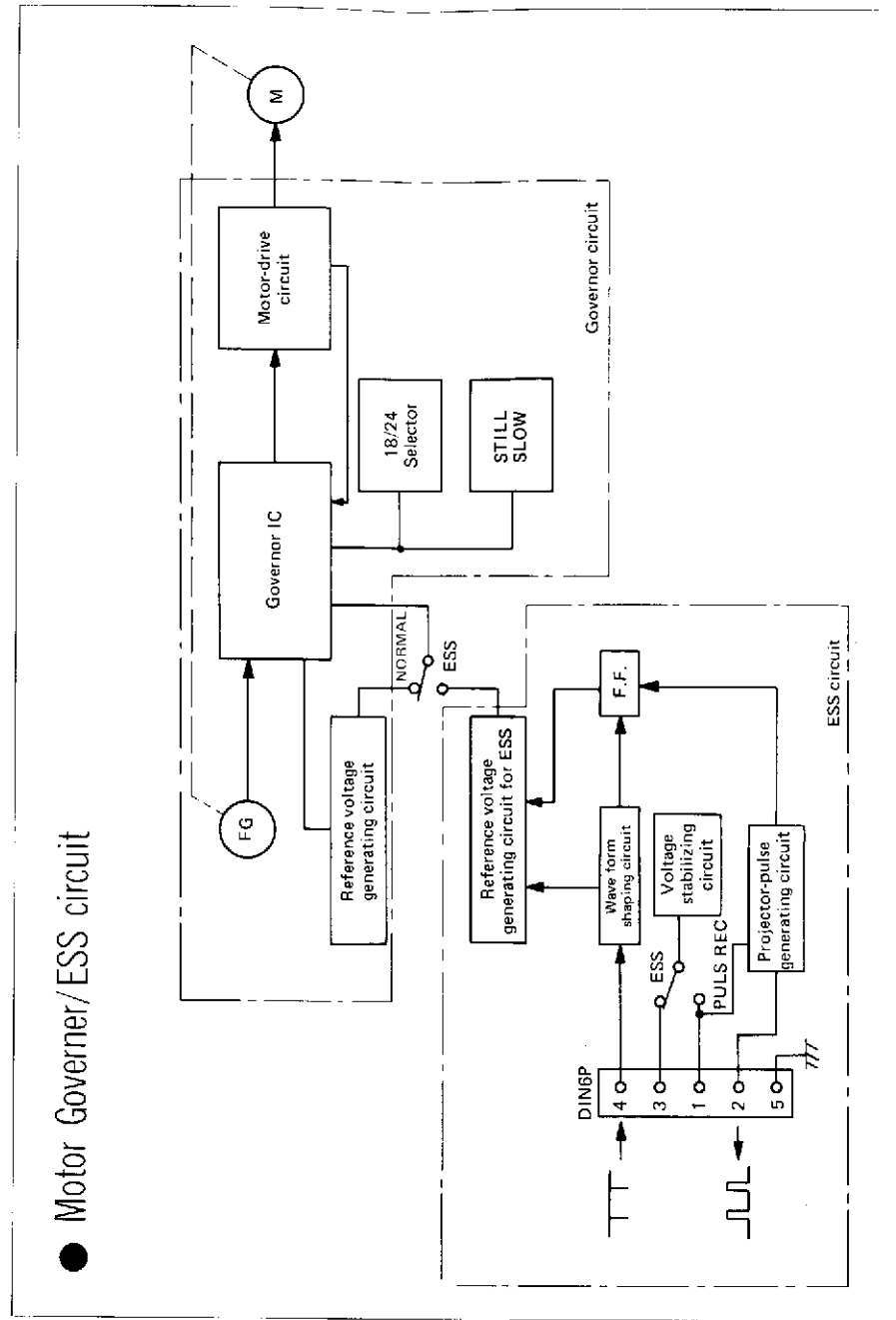

# Control circuit

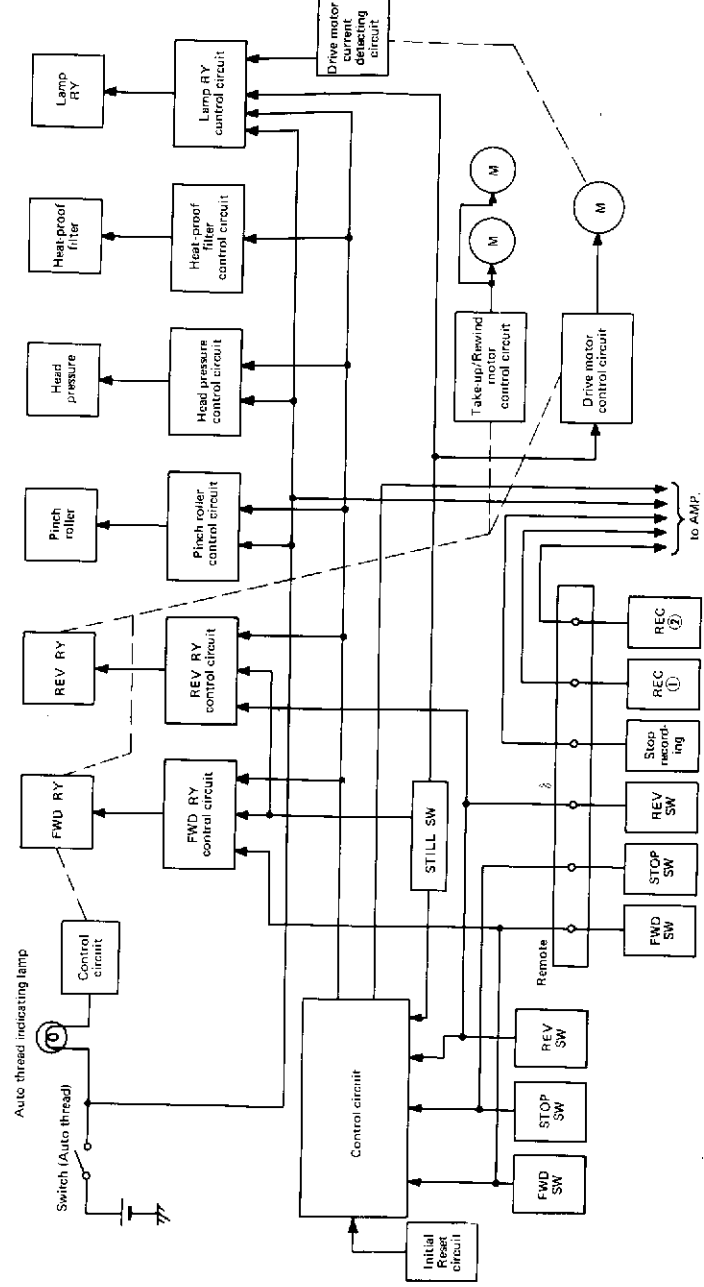

# Amplifier

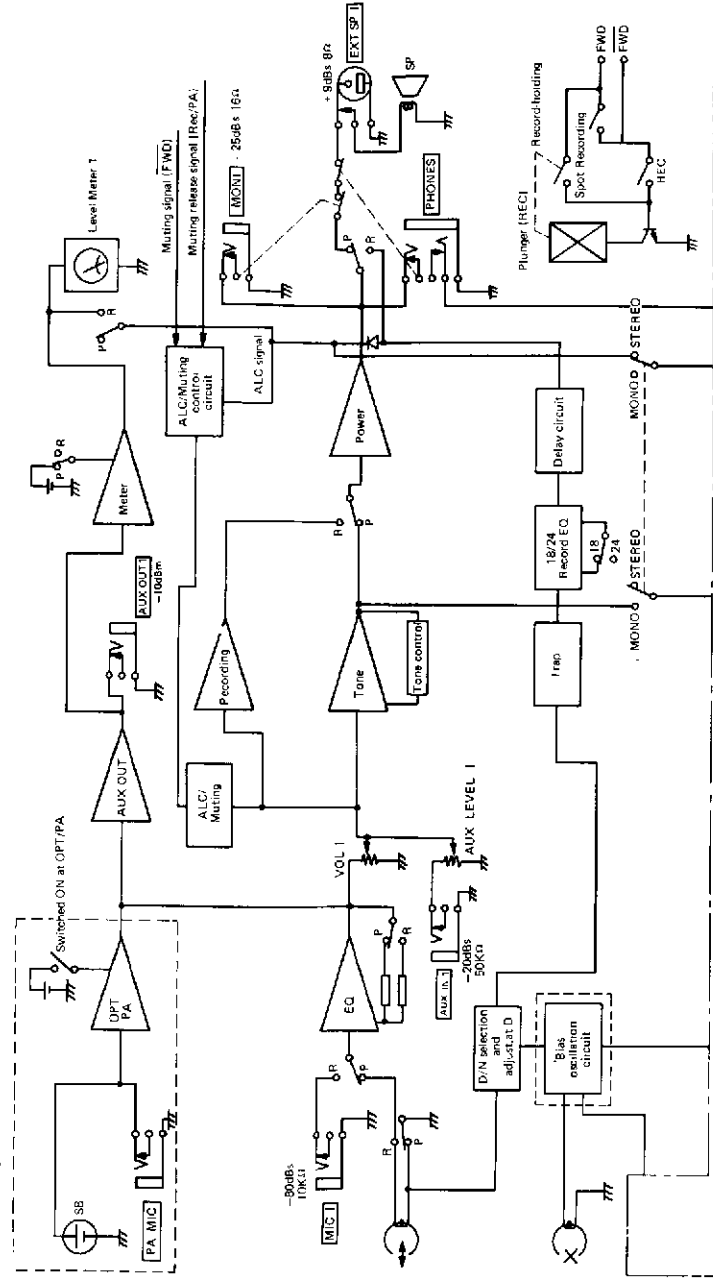

Amp. circuit for track 2 (same as track 1 except parts shown bounded by dotted line.)



Projection distance and

Projection time and film length

Focal length	12.5 mm	15 mm
Distance	Image size (cm)	Image size (cm)
1 m	31 x 42	26 x 35
1.5 m	47 x 63	39 x 52
2 m	63 x 85	52 x 70
2.5 m	79 x 106	66 x 88
3 m	95 x 128	79 x 106
5 m	160 x 213	133 x 178
10 m	320 x 428	266 x 356

Time (min.)	24 fps		18 fps		m	24 fps		18 fps	
	m	ft	m	ft		m	ft	m	ft
1	6.1	20	4.6	15	2	128.0	420	96.0	315
2	12.2	40	9.1	30	3	134.1	440	100.6	330
3	18.3	60	13.7	45	4	140.2	460	105.2	345
4	24.4	80	18.3	60	5	146.3	480	109.7	360
5	30.5	100	22.9	75	6	152.4	500	114.3	375
6	36.6	120	27.4	90	7	158.5	520	118.9	390
7	42.7	140	32.0	105	8	164.6	540	123.4	405
8	48.8	160	36.6	120	9	170.7	560	128.0	420
9	54.9	180	41.1	135	10	176.8	580	132.6	435
10	61.0	200	45.7	150	11	182.9	600	137.2	450
11	67.1	220	50.3	165	12	189.0	620	141.7	465
12	73.2	240	54.9	180	13	195.1	640	146.3	480
13	79.2	260	59.4	195	14	201.2	660	150.9	495
14	85.4	280	64.0	210	15	207.3	680	155.4	510
15	91.4	300	68.6	225	16	213.4	700	160.0	525
16	97.5	320	73.2	240	17	219.5	720	164.6	540
17	103.6	340	77.7	255	18	225.6	740	169.2	555
18	109.7	360	82.3	270	19	231.7	760	173.8	570
19	115.8	380	86.9	285	20	237.8	780	178.4	585
20	121.9	400	91.4	300		243.9	800	183.0	600

Focal length	25 mm	50 mm (Optional accessory)
Distance	Image size (cm)	Image size (cm)
1 m	15 x 20	7 x 10
1.5 m	23 x 31	11 x 15
2 m	31 x 42	15 x 20
2.5 m	39 x 52	19 x 26
3 m	47 x 63	23 x 31
5 m	79 x 106	39 x 53
10 m	160 x 213	79 x 106
15 m	240 x 320	119 x 160
20 m	320 x 428	160 x 213
30 m		240 x 320
40 m		320 x 428

Film	Super 8 sound and silent films
Projection lens	F1.1, 12.5 — 25 mm zoom lens
Projection lamp	24V-200W Halogen lamp with dichroic mirror.(Code ESC) High and low brightness selection possible. Pre-heated.
Film loading	Fully automatic loading
Film capacity	Max. 360m (1,200ft)
Motor	4 motors used. Main electronic governor motor, Take-up motor, Rewind motor and Cooling fan motor.
Projection speed	18 and 24 fps
Still picture projection	Possible
Slow projection	Possible
Reverse projection	Possible
Remote control	Forward and reverse projection and switch-over of magnetic recording and reproduction can be remotely controlled.
Film rewinding	High speed rewind
Film counter	Built-in
Sound system	Magnetic and optical sound reproduction and magnetic recording
Magnetic recording	Simultaneous sound recording on Track 1 (Main stripe) and on Track 2 (Balance stripe) for true stereo sound. Individual recording on Track 1 or on Track 2 is also possible. Sound-on-sound recording is also feasible in all sound recording modes.
Magnetic reproduction	Stereo sound reproduction and individual reproduction of either track.
Monitoring	Possible. While recording on one track, monitoring of the other track is possible.
Exciter lamp	4V-0.75A (Type KE-02, Code BRS)

Amplifier	6 IC's and 18 transistors. Stereo amplifiers
Music power output	15W + 15W (8 ohms)
Continuous power output	10W + 10W (8 ohms)
Recording level control	Microphone: Automatic and manual control. Auxiliary input: Automatic and manual control.
Level indication	The illuminated built-in meter indicates recording and output levels.
Frequency response	50Hz — 13,500Hz at 24 fps
Tone control	Bass and treble separate control.
Spot recording	Possible
Public address	Possible
Auxiliary input/output	Equipped
Input terminals	Aux. In (x2): Impedance 50K $\Omega$ each, more than -20 dBs Mic. (x2): 500 $\Omega$ — 10K $\Omega$ each, -72 dBs ~ -30 dBs
Output terminals	Ext. Sp. (x2): 8 $\Omega$ each Aux. Out (x2): 600 $\Omega$ each Moni. (Stereo headphone): 8 ~ 16 $\Omega$ Moni. (Earphone, x2): 8 ~ 16 $\Omega$ each
Pulse synchronization	Possible. While projecting with pulse synchronization, magnetic recording or reproduction is possible.
Speaker	Two 12.5cm (5 inches) dynamic speakers built-in. Extension speaker can be used.
* Microphone	Electret condenser microphone (Impedance: 600 $\Omega$ )
Power source	AC, 50/60Hz
Dimensions & Weight	385 x 284 x 219mm (15.2 x 11.2 x 8.6 inches) 14 kgs. (31 lbs.)
* Before using the microphone, be sure to install 1 pce of AA battery (pen-light) in it, or it does not function.	

(The above specifications are subject to change without notice.)



**ELMO CO., LTD.**

Nagoya, Japan

**OVERSEAS SUBSIDIARY COMPANIES**

**U.S.A.**

**Elmo Mfg. Corp.**

70 New Hyde Park Road, New Hyde Park, NY 11040

Tel. (516) 775-3200

21220 Erwin Street, Woodland Hills, CA 91367

Tel. (213) 346-4500

**Canada**

**Elmo Canada Mfg. Corp.**

44 West Drive, Brampton, Ontario L6T 3T6

Tel. (416) 453-7880

1975 Maple Street, Vancouver, B.C. V6J 3S9

Tel. (604) 738-1215

**West Germany**

**Elmo (Europe) G.m.b.H.**

Elmo-Haus, Steinstr. 23, 4000 Düsseldorf

Tel. (0211) 84231, 84232